

Pensotti ASME Condensing Boilers

Troubleshooting Manual

Version 1 - All Models



Pensotti ASME Condensing Boilers

Table of Contents

Introduction	Pg. 3
List of Error Codes	Pg. 4
Retrieving Error Code History	Pg. 5
Information Button	Pg. 6
Dedicated Electrical Circuit – Earth Ground	Pg. 7
LCD Screen Is Blank	Pg. 8-10
E01 Error Code – No Ignition	Pg. 11-16
E01 Error Code – With Ignition	Pg. 17-21
E02 Error Code	Pg. 22-26
E03 Error Code	Pg. 27-31
E04 Error Code	Pg. 32-34
E05 Error Code	Pg. 35-37
E06 Error Code	Pg. 38-40
E16 Error Code	Pg. 41-42
E18 Error Code	Pg. 43-45
E21 Error Code	Pg. 46
E22 Error Code	Pg. 47
E35 Error Code	Pg. 48-50
E40 Error Code	Pg. 51
Function Code Introduction & Descriptions	Pg. 52-54
Low Fire CO2 Adjustment	Pg. 55-56
Diverter Valve Operation	Pg. 57-60
No Hot Water - Domestic Hot Water Flow Switch Operation	Pg. 61-65
No Hot Water – Domestic Hot Water Sensors	Pg. 66-67
Domestic Hot Water Production Capability	Pg. 68-69
Low Fire Rumble or Whistle	Pg. 70-76

Error Codes

If a problem arises, the self diagnostics of the Pensotti Main PCB will display an error code for a number of internal component problems.

Error Code **E0_**



Error Codes

Error Code Displayed	Reset Method
E01 Flame Failure	Manual Reset Button
E02 High Limit Safety Thermostat Circuit Open	Manual Reset Button
E03 Flue Temperature Thermo-Fuse Circuit Open	Manual Reset Button
E04 Low Water Pressure – Heating Circuit	Automatic Upon Repair
E05 Heating Sensor Circuit Open or Shorted (NTC)	Automatic Upon Repair
E06 D.H.W. Sensor Circuit Open or Shorted (NTC)	Automatic Upon Repair
E16 Combustion Fan Failure	Automatic Upon Repair
E18 Inadequate Boiler Water Circulation	Automatic Upon Repair
E21 PCB Malfunction	Automatic Reset
E22 Parameters Need to be Programmed	Manual Reset – Switch Off Power Supply
E35 Flame Ionization Circuit Malfunction	Manual Reset Button
E40 Power Supply Out of Range	Automatic Upon Voltage Correction

Retrieving Error Code History

If a problem did arise, and the Error Code had been cleared. The previous 5 error codes generated by the boiler are saved in the Processor and can be displayed by using the **INFO** (i) button .

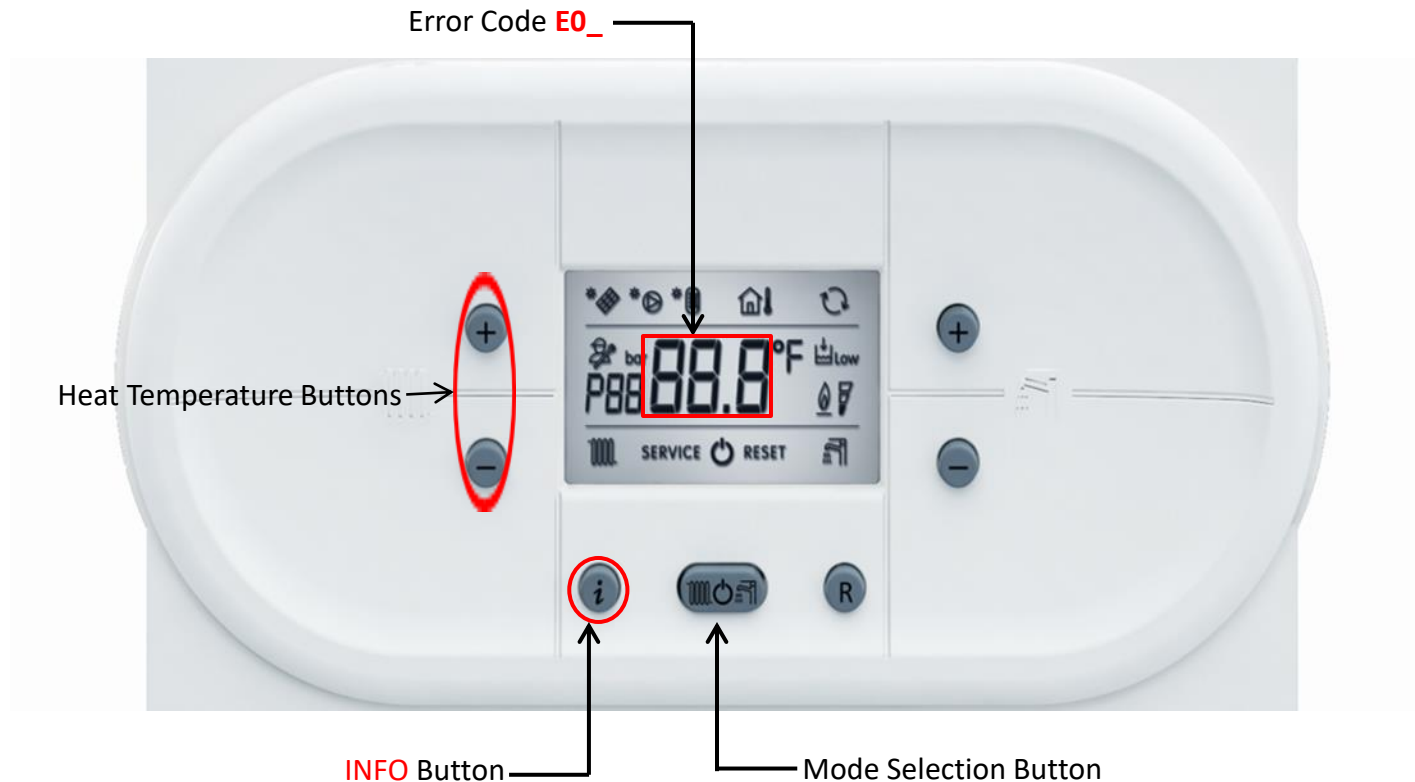

To access error code history: Turn the boiler off using the Mode Selection button. Press and hold the **INFO** button for several seconds. The last 5 error codes will now be displayed, starting with the most recent. Scroll through the history using the heat temperature + and - buttons. Press the **INFO** button to escape. See Instruction Manual for additional information.

INFO Menu Display

Pressing the **INFO** (i) button, while the boiler is in an operating mode, will display data that can be helpful when troubleshooting certain problems. Press the Heat Temperature + and – buttons to scroll through the choices.

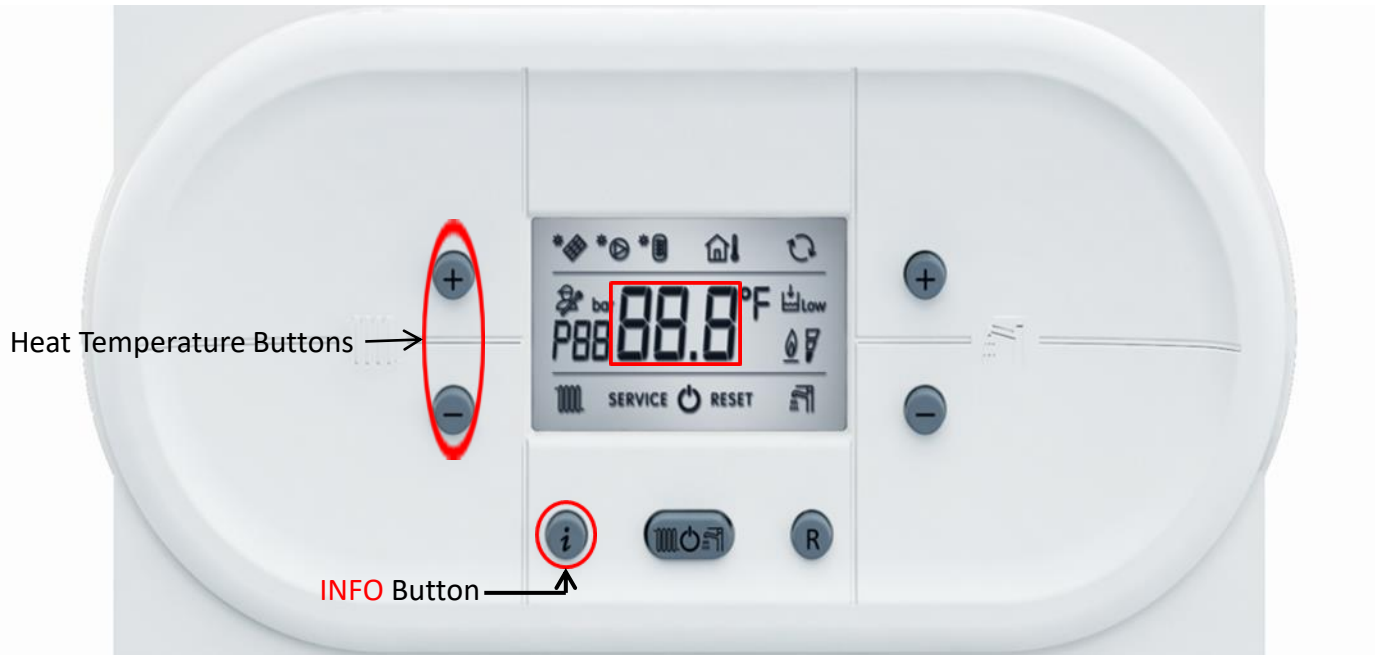

Parameter	Description
d00	D.H.W. Temperature at the Sensor
d01	Outdoor Sensor Temperature (if installed)
d02	Fan Speed (hz)

Dedicated Electrical Circuit and Proper Earth Ground

All Pensotti Condensing Boilers Require a Dedicated Circuit and Proper Earth Ground

The information contained within this troubleshooting guide is based on the premise that the boiler is properly wired to a dedicated circuit with a reliable earth ground.

Failure to follow these compulsory requirements can lead to unreliable boiler operation and the production of erroneous error codes.

Before beginning any troubleshooting procedure, verify that the aforementioned requirements have been adhered to.

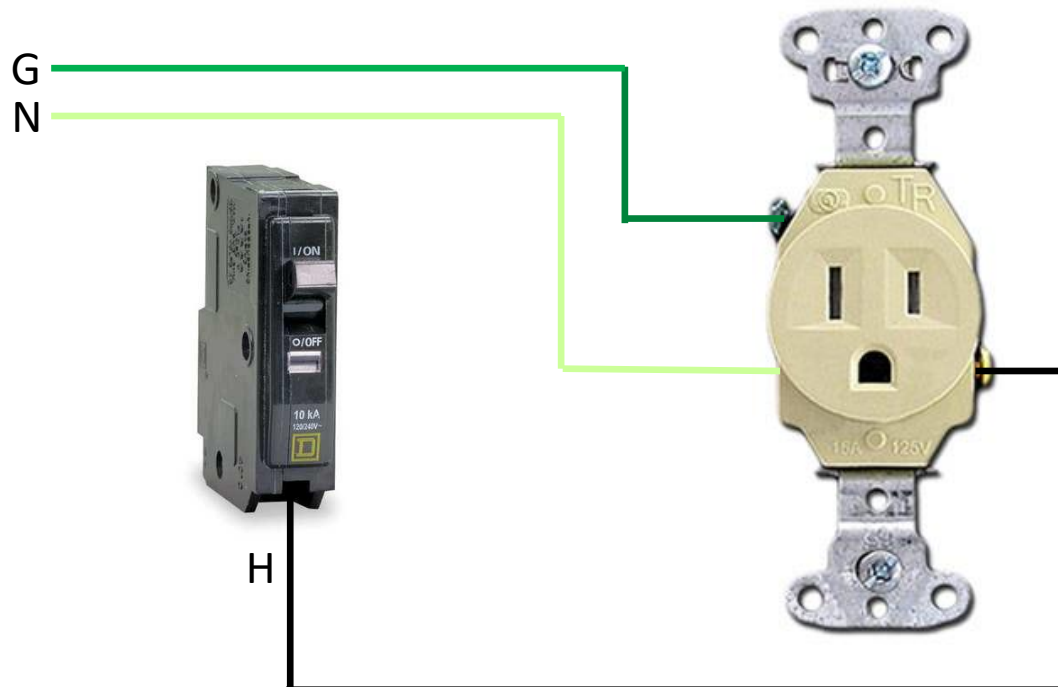

LCD Display Is Blank

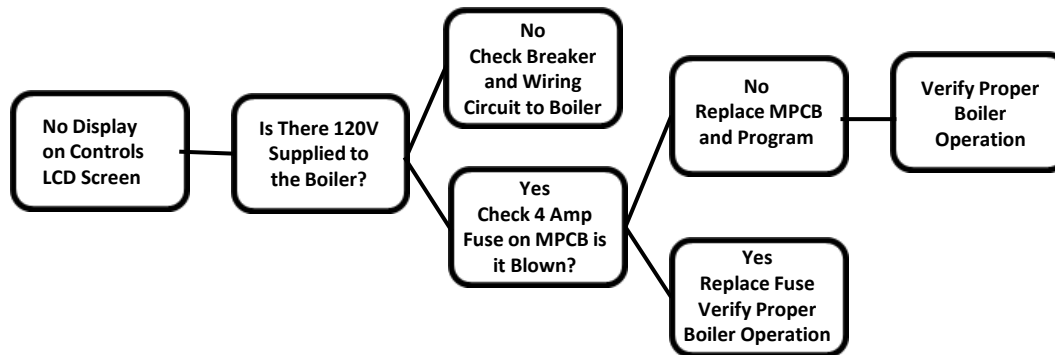

LCD Display Is Blank

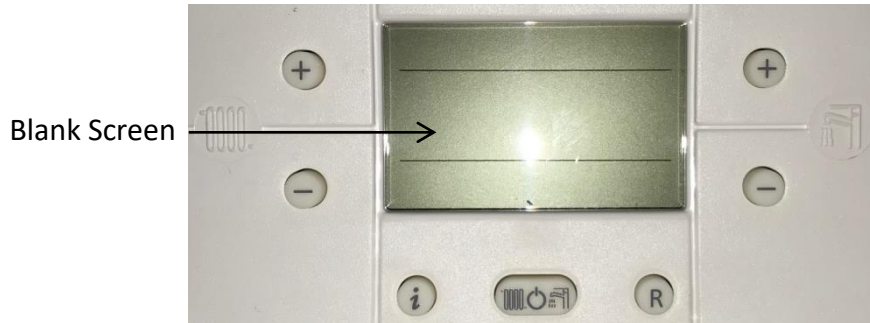

Check for power to boiler

- Remove boiler cover
- Remove wiring access cover
- Check for 120V between terminals **L** and **N**. If no power is present, check the buildings wiring circuit to the boiler for an open breaker or switch.

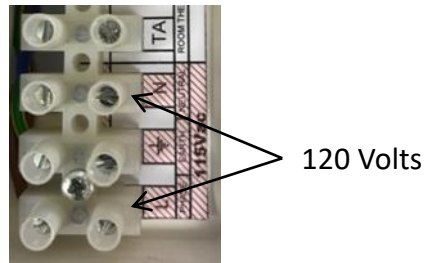

Power at Boiler – Check MPCB Fuse

- Disconnect power to the boiler
- Remove back cover of control panel by removing the four Philip head screws
- Locate 4 amp fuse in the MPCB (refer to picture on page 9) and carefully remove
- Using an Ohms meter, check for continuity across the fuse. If open, defective, swap with an exact replacement
- Reconnect power to the boiler and verify proper boiler operation
- Replace the back cover of the control and secure with the four screws

LCD Display Is Blank

4 Amp Fuse

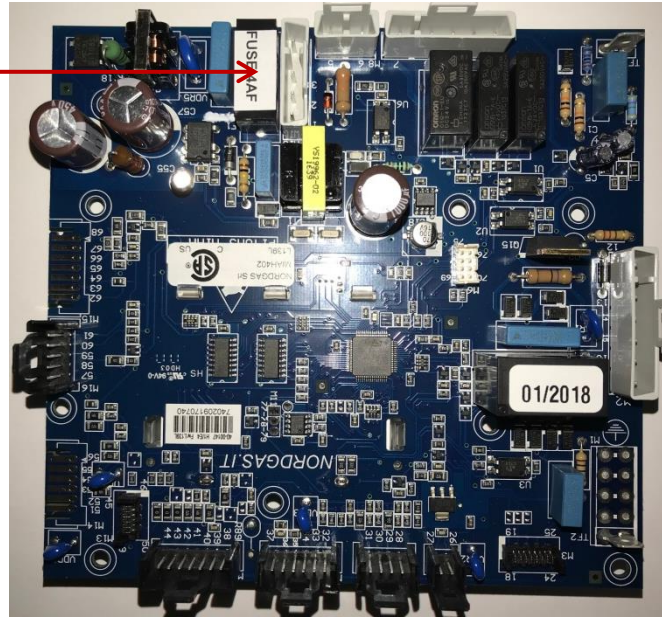

MPCB Defective

- If continuity test verifies the fuse is in good repair, the MPCB is defective
- Disconnect power to the boiler
- Carefully remove the wire cable connections from the MPCB
- Remove the Philip head screws that secure the MPCB to the front cover.
- Secure the MPCB fascia cover and buttons to the front control cover
- Remove the defective MPCB
- Install the new MPCB and connect all the wire cables securely (click into place to secure)
- Verify the MPCB fascia cover and buttons are in place and secure
- Secure the MPCB with the Philip head screws
- Replace the controls back cover and secure with the four Philip head screws
- Reconnect power to the boiler
- Program the parameters to match the boiler model (refer to Instruction Manual Section 5 for information)
- Enable heat and hot water demands, cycle boiler and check for proper operation

E01 Reset – No Ignition

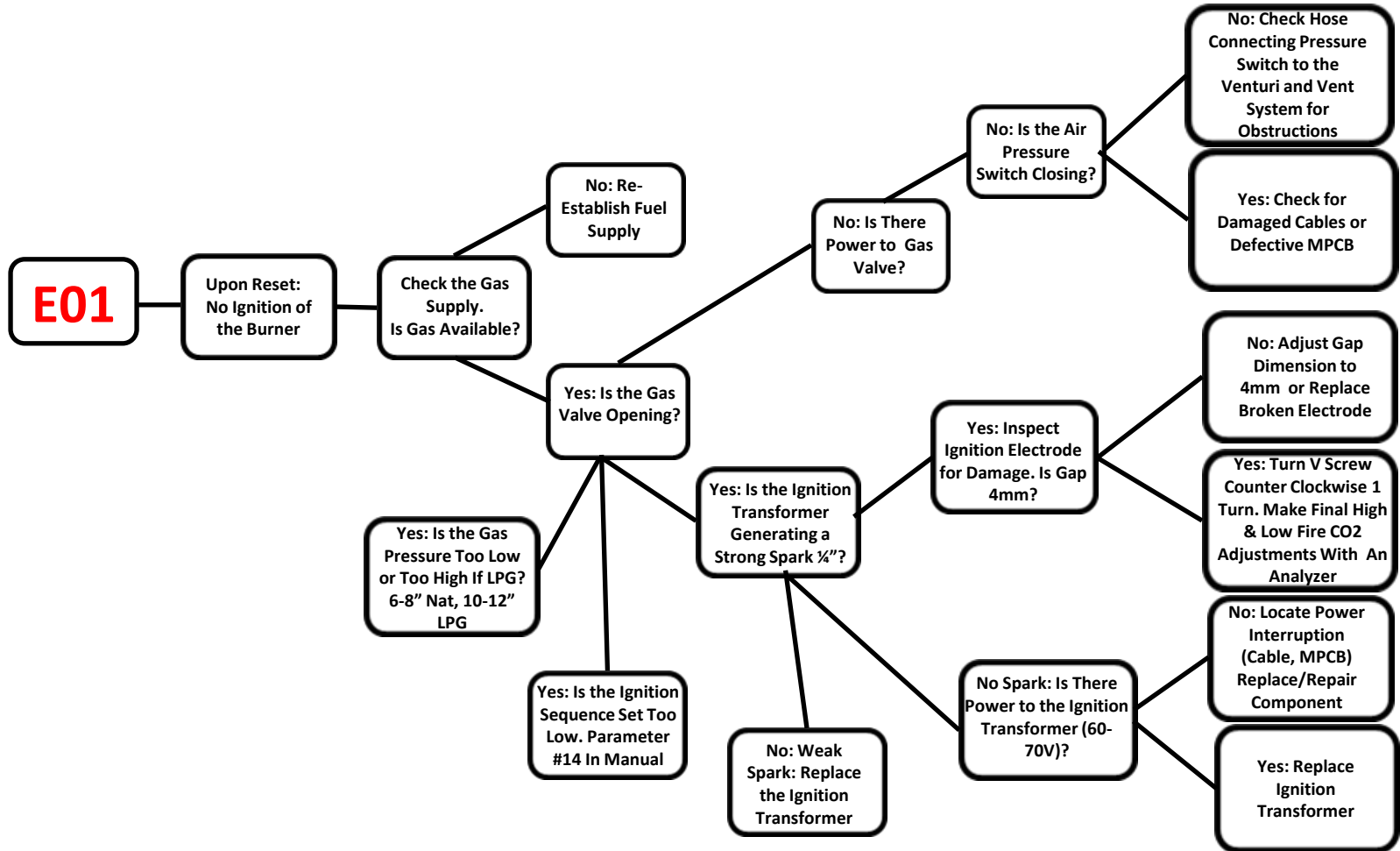

Note. New Boiler: If an E01 error code is being generated on a new boiler at the time of commissioning or shortly afterwards, and the remedies above have not been successful, refer to page 15 for an additional procedure.

E01 Reset – No Ignition

1. Gas Inlet Pressure Too Low or Too High (Too High in The Case of LPG Boilers)

Disconnect power to the boiler. Shut off the gas cock. Open, then install a manometer on the inlet side test port (bottom) of the gas valve (see picture). Open gas cock and verify there is enough gas pressure displayed on the manometer. Minimum gas pressure 5"wc, maximum pressure 14"wc. Natural gas 5-8"wc, LPG 10-14" wc. If the gas pressure is out of range check fuel supply and/or regulators, adjust or replace as necessary.

Gas Inlet Pressure In Excess Of 14" wc Will Damage The Gas Valve.

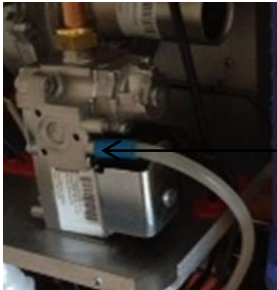

Loosen Screw, Do Not Remove, Connect Hose

2. Verify Gas Valve Operation

With manometer installed on the opened inlet pressure test port of the gas valve, and the gas cock open, observe the gas pressure (lock-up or static pressure). Attempt to ignite the boiler. When the boiler goes through its ignition sequence, observe if the pressure on the manometer drops. If the pressure drops the gas valve is not defective. If the pressure remains steady at the lock-up pressure, the gas valve is defective or it is not being electrically activated.

3. No Electrical Power to the Gas Valve During the Ignition Sequence

Using a multi-meter check for approximately 65 volts at the gas valve cable connector (see picture below). If no or low power is detected between the green and blue wires the air pressure switch circuit may be open. Turn the boiler off and remove the two wires from the pressure switch (Brown and Blue, observe which terminals they are connected to). Install a jumper in between the two wires and attempt to ignite the boiler. If the boiler lights check the rubber hose between the pressure switch and the Venturi for proper connection and/or air leaks. Reattach or replace if necessary. Check the combustion air and exhaust pipes for obstructions, clear if necessary. If hose and venting system are in good repair, replace air pressure switch.

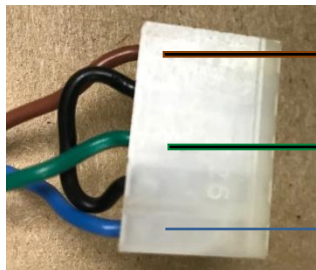

65 Volts AC During Ignition Sequence

Constant 65 Volts AC When Burner is Operating

E01 Reset – No Ignition

4. Testing the Ignition Transformer

Disconnect power to the boiler and shut the gas cock. Remove the high voltage lead from the ignition transformer and leave a 3/8" gap between it and the terminal. Turn the boiler on and observe the spark intensity during the ignition sequence. It should appear blue in color and be able to jump at least a 1/4" gap. If the spark appears weak, replace the ignition transformer.

5. No Spark from the Ignition Transformer

Disconnect power to the boiler and shut the gas cock. Remove the power cable from the ignition transformer. Insert the leads of a multi-meter, set to AC Volts, into the terminal ends of the cable. Turn the boiler on. During the ignition sequence you should have approximately 65 volts. If 65 volts are present, replace the defective ignition transformer.

If no voltage is detected, check for power at the ignition transformer cable connection on the MPCB. If power is present, check the cable for continuity and cable ends for tightness to the terminals. Repair or replace as necessary.

If no voltage is detected at the MPCB terminals during the ignition sequence, replace the MPCB.



3/8" Gap



65 Volts AC During Ignition Sequence

6. Acceptable Spark is Present at the Ignition Transformer

Disconnect power to the boiler and shut the gas cock. Remove the ignition electrode and inspect the insulator for damage such as cracks or pitting, replace if necessary. Always replace the gasket. If not damaged verify that the gap is 4mm. Adjust, if necessary, by gently manipulating the ground rod (no Insulator) with finger or thumb pressure until the 4mm gap is achieved. **Do not attempt** to bend the rods, they may break. Once adjusted, reconnect all the wires to the ignition transformer and ground. Hold the electrode by the cable, keeping it away from all adjacent items, turn the boiler on and during the ignition sequence observe the spark across the gap. If spark is not present, recheck the cable connections. If spark is still not present, replace the electrode. Secure the electrode in the boiler with a new gasket, open the gas cock and restore power to the boiler.

4mm Gap



E01 Reset – No Ignition

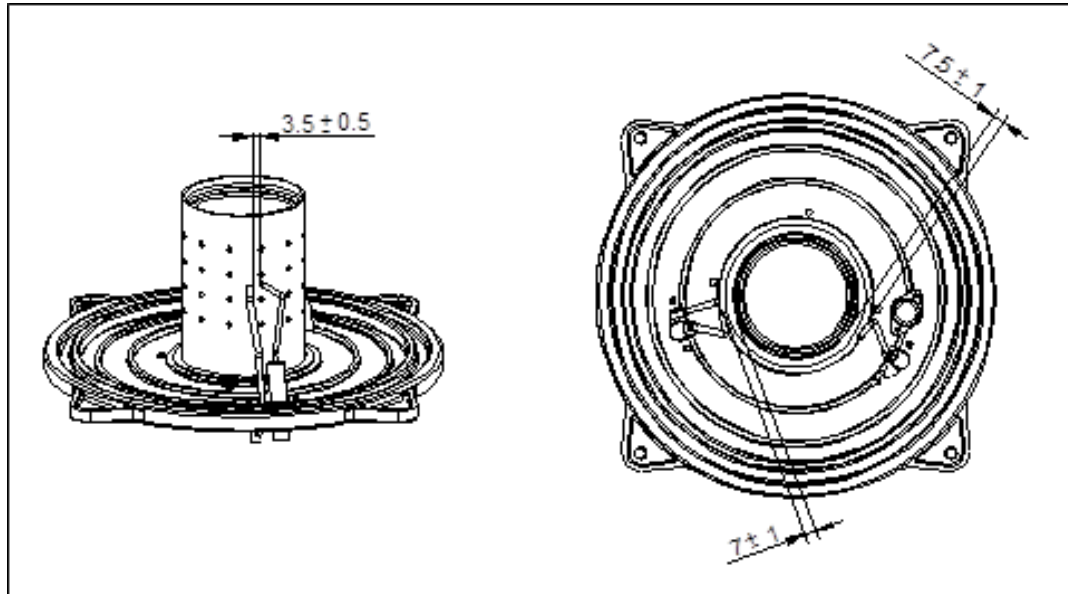

Electrode gap to the burner can only be measured by removing the burner assembly. Rarely does a variance in this measurement cause an E01 Error. The illustration above provides the gap, in mm, for both the ignition electrode and ionization electrode.

7. V Screw in the Venturi is Not Properly Adjusted

With the boiler turned off, insert a 4mm Allen wrench into the V screw. Turn the screw one complete turn **counter-clockwise**. Turn the boiler on. After the boiler lights force it into high fire mode (refer to the installation manual, section 5) and by means of a combustion analyzer, verify and adjust both the high fire and low fire CO₂ to the proper values, see table on page 20 for high fire CO₂ values. Refer to the Low Fire CO₂ Adjustment section on page 54.

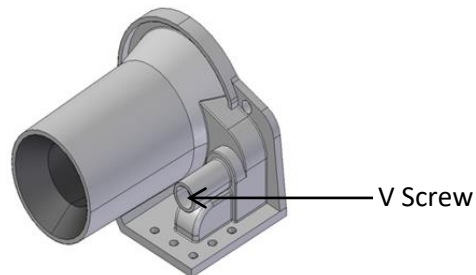

E01 Reset – No Ignition

New Boiler is Generating an E01 Error Code at Commissioning or Shortly Thereafter:

Occasionally, the stainless steel mesh cover of a burner will have stray 'hairs' that lift off the burner surface and come in contact with, or in close proximity to, the ignition electrode. When this occurs, the ignition circuit becomes grounded and thus ineffective, causing no ignition and an E01 error code to be generated (see picture below).

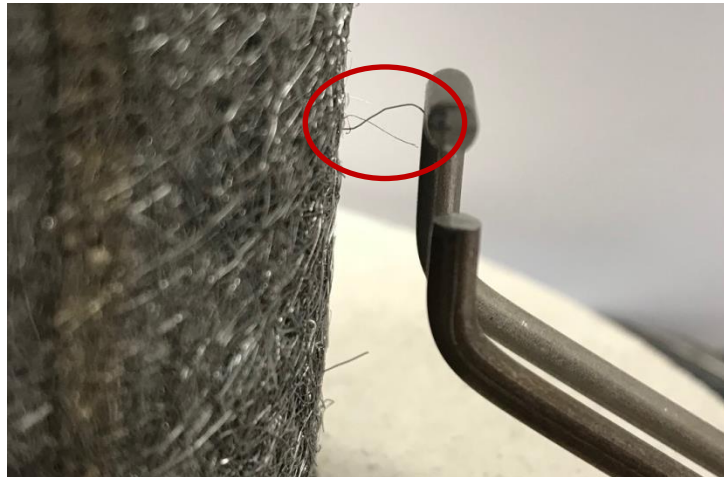

Remedy Procedure:

- Disconnect power to the boiler
- Turn the gas cock off
- Disconnect the cable from the ionization rod
- Disconnect the ignition electrode high tension cable from the ignition transformer
- Disconnect the ignition electrode ground wire
- Disconnect the power cable from the gas valve
- Disconnect the 4 wire cable from the combustion fan
- Remove the gas line fittings from both the inlet and outlet of the gas valve, remove the 2 gaskets and save
- The gas valve is held to the metal pan beneath it by Philip head screws. Remove the 2 that are **not** recessed into the metal surface and save
- Using a 10mm wrench or socket, loosen, but don't remove the 4 nuts that secure the burner to the heat exchanger
- Separate the burner assembly from the heat exchanger while holding the gas valve
- The movement of the burner will now provide easier removal of the gas valve. Place in a clean, dry location

E01 Reset – No Ignition

- Remove the 4 – 10 mm burner nuts while holding the burner securely
- Ease the burner assembly from the boiler, **Remember a cable is still connected to the fan**
- Once the burner assembly is removed, rotate it to gain access the power cable on the fan and remove
- Place burner assembly in convenient location for inspection
- Remove any lifted burner 'hairs' in the vicinity of both the ignition electrode and ionization rod by cutting them near the burner surface with a pair of sharp scissors
- Verify the proper gap between the electrodes and burner surface using a 7mm Allen wrench, adjust if necessary
- Carefully reinstall the components
- Verify the tightness of all fittings, nuts, screws and wires
- Reconnect power to the boiler
- Turn the gas cock on and check for leaks.
- Turn the boiler on using the mode selection switch
- Enable a heat or hot water call
- Verify proper burner ignition and boiler operation

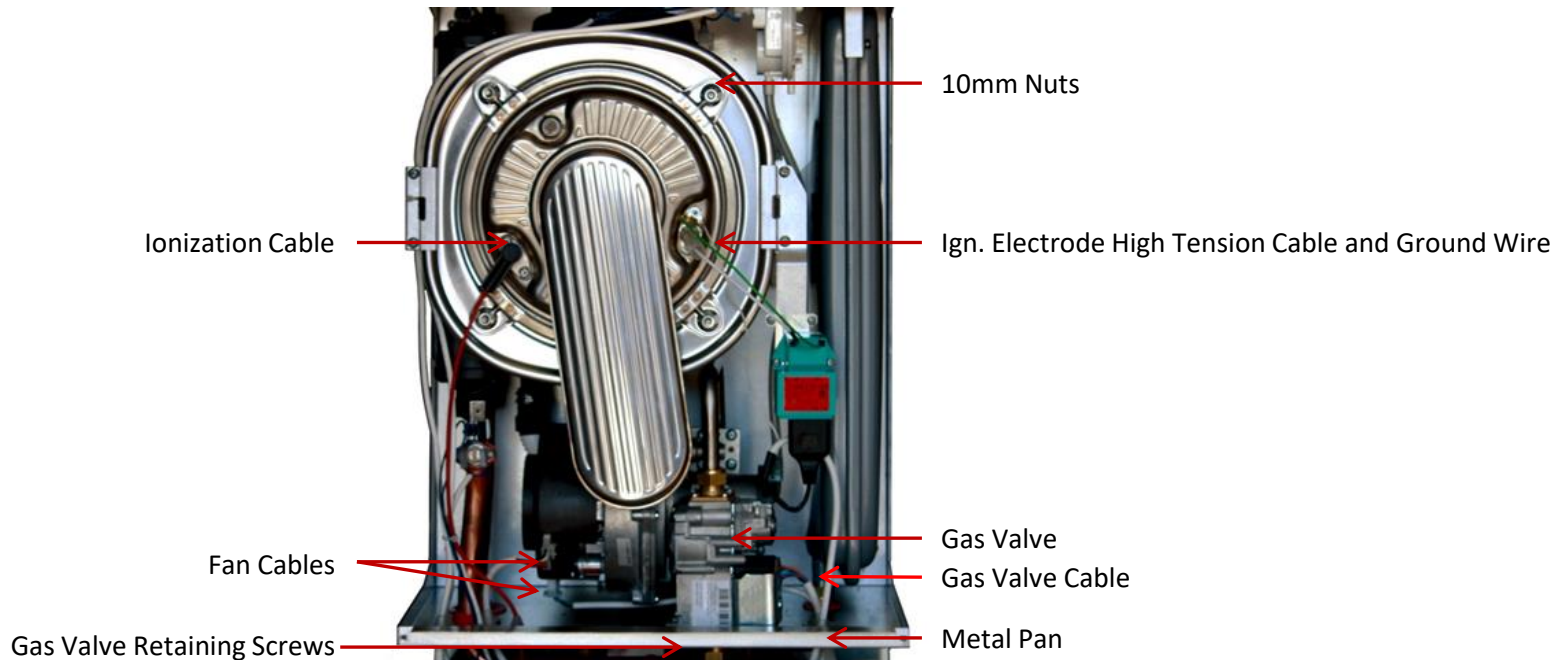

E01 Reset – With Ignition

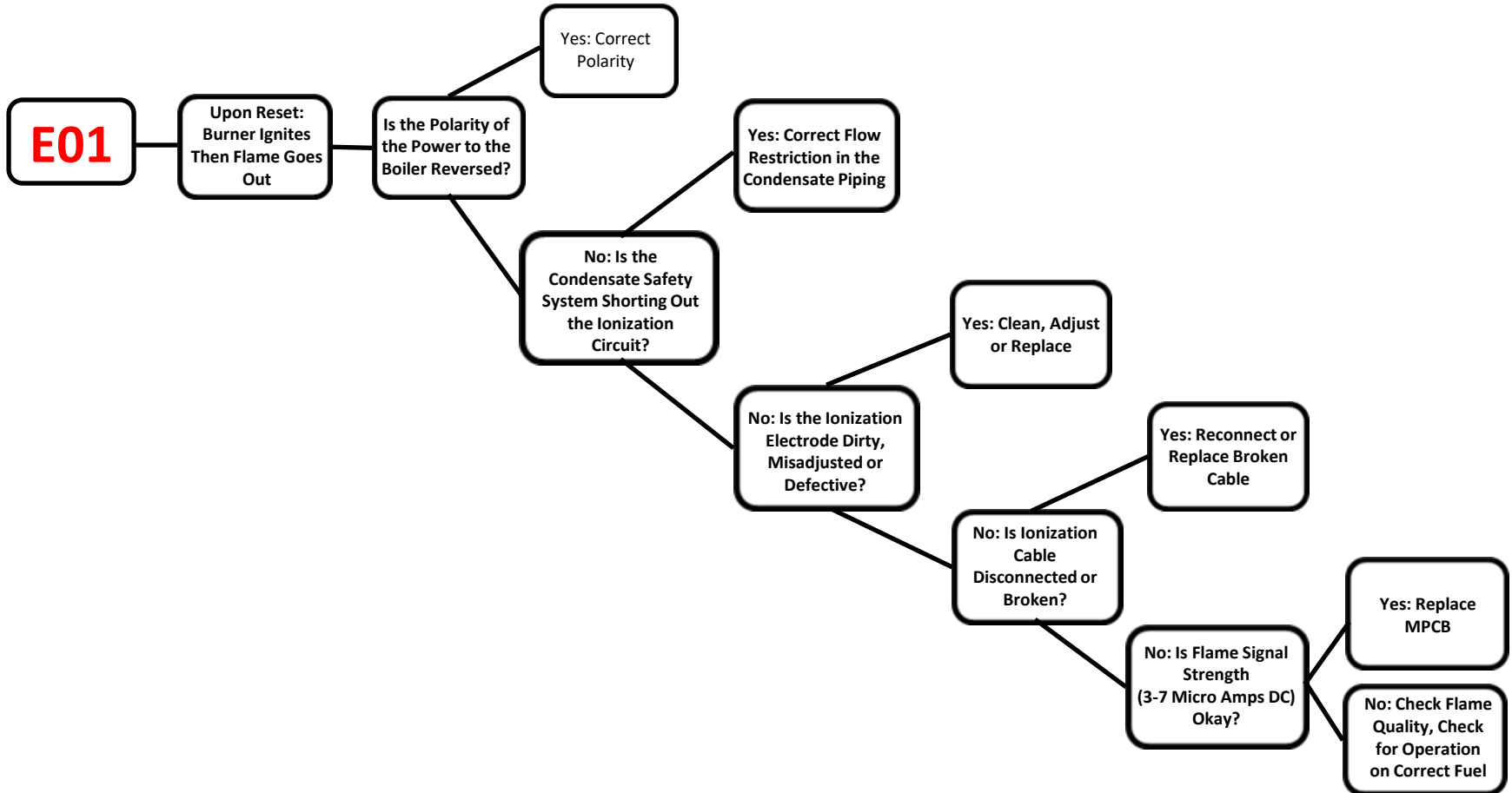

E01 Reset – With Ignition

1. The Polarity of the Incoming Power to the Boiler is Reversed

All Pensotti gas boilers are polarity sensitive. 120 Volt AC Hot must be connected to L terminal on the power strip, N must be Neutral and the ground terminal must be connected to an earth ground. If L and N are reversed the flame safety circuit will be grounded and unable to detect the presence of a flame. In most cases the improper wiring will be found within the buildings power outlet. **The power outlets circuit must be dedicated to the boiler only.** Other devices connected to the same circuit can effect boiler operation.

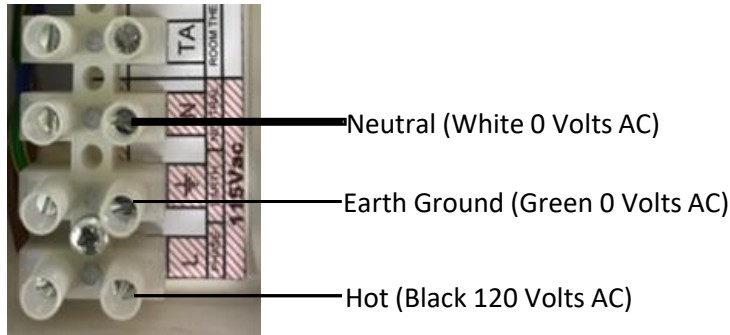

2. Condensate Safety System is Activating

The condensate safety system is designed to ground out the flame safety circuit when condensate is present at the top of the condensate trap. The condensate within the trap becomes the conduit to ground of the flame safety circuit. If the condensate trap is full or the inside of the siphon cap at the top of the trap is wet (has ground wire connected to it), identify the reason why condensate flow is impeded and correct the problem. Test for proper condensate flow and correct any restrictions, Dry the siphon cap and reinstall. This problem can also occur upon flushing the heat exchanger with water after cleaning.

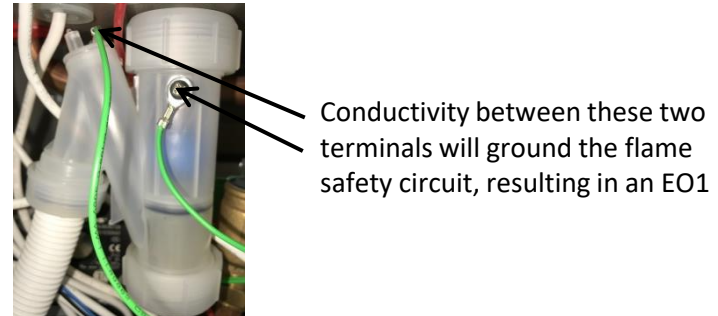

E01 Reset – With Ignition

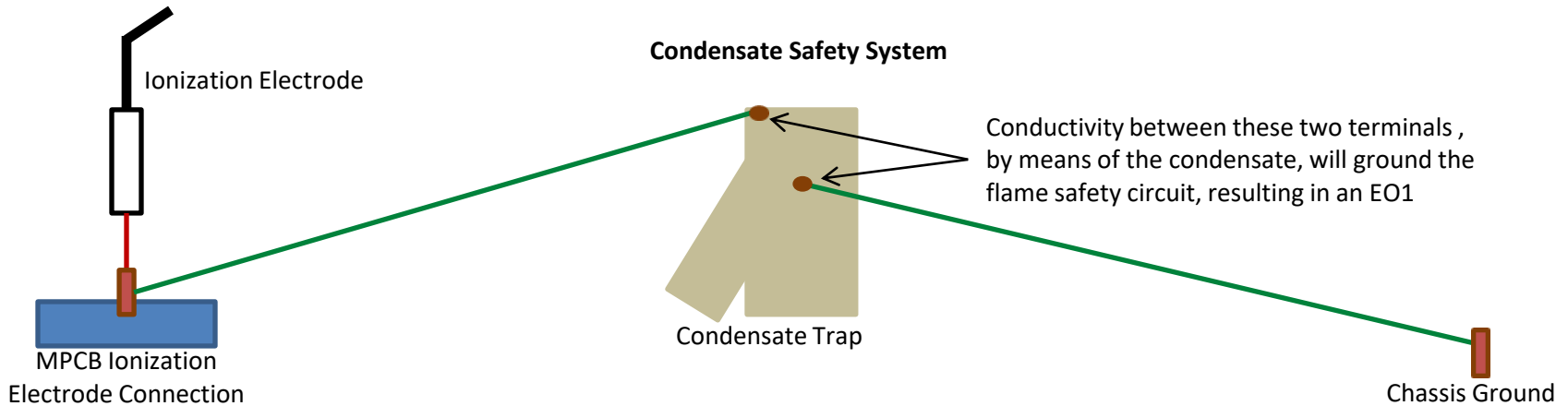

3. Ionization Electrode is Dirty or Misadjusted

Disconnect power to the boiler and shut the gas cock. Remove the Ionization electrode and inspect the insulator for damage such as cracks or pitting. Clean the electrode with a soft cloth only. If found to be damaged, replace it along with a new gasket.

4. Inspect Ionization Electrode Cable.

Visually inspect the integrity of the ionization cable. If damaged or broken, replace it. Using an Ohms meter, check the continuity of the cable. If an open circuit is revealed replace the cable. Check the cable ends for a proper fit to both the Ionization electrode and the MPCB. If connections are loose, tighten by squeezing the cable end slightly. Recheck for tightness.

5. Check Flame Signal Strength

Using a **DC microamp meter**, check the flame signal strength. A normal reading is 3-7 microamps. The MPCB will lock out (generate an E01 Fault) with a flame signal of less than .5 microamps.

Turn the boiler off, insert the microamp meter in series between the Ionization Electrode and MPCB. Turn the boiler on and allow it to ignite, observe the reading on the meter for a moment. If using an analog meter and the value drops below 0, reverse the meters test leads. If the reading falls into the normal ranges listed above, and the E01 fault is still generated, the MPCB is defective and will need to be replaced.

If the flame signal strength is low and all the items 1-4 above have been verified, the ionization electrode gap to the burner surface will need to be measured and adjusted.

E01 Reset – With Ignition

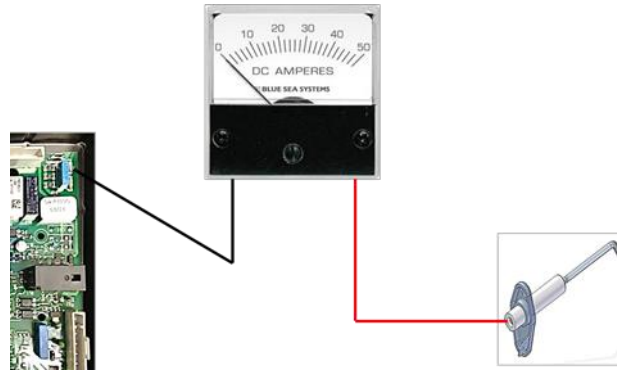

6. Verify the Ionization Electrode Gap

Disconnect power to the boiler and shut the gas cock. Remove the burner from the boiler (see instruction manual section 6.7). Using a 7 mm Allen Wrench, gauge the distance between the burner and ionization electrode. The proper gap is 7.5mm + or – 1mm. Adjust the electrode as necessary to achieve the proper gap. Be careful not to break the electrode. If a new ionization electrode is installed its gap will need to be verified and adjusted. Reassemble the boiler, turn the gas cock on and check for gas leaks and disconnected cables. Turn the boiler on and repeat the microamp test. Verify the proper value (3-7 microamps).

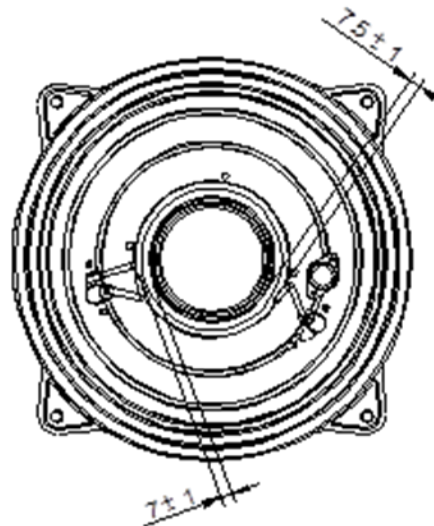

E01 Reset – With Ignition

7. Check Flame Quality

If the microamp reading is still low after completing items 5 & 6 above, the flame quality will need to be verified. Check both the incoming gas pressure, and using a combustion analyzer, the flame quality through a high fire CO₂ test. Verify that the test value matches the value in the table below. Refer to the Installation Manual section 5.

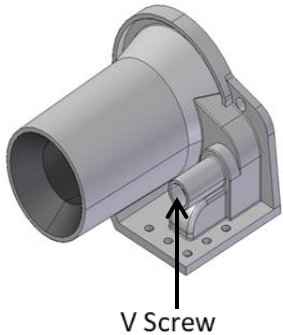

Boiler Model	Gas Type	CO ₂ %
PCH 34B H	Nat	9.1
	LPG	10.3
PCH 50B H	Nat	9.4
	LPG	10.3
PCC 34 H	Nat	9.1
	LPG	10.3
PCI 18/8 H	Nat	9.3
	LPG	10.1
PCI 34/20 H	Nat	9.1
	LPG	10.3

E02 High Limit Safety Thermostat

Note: Usually, the High Limit Safety fault is the result of a problem and not a defective High Limit Safety Thermostat

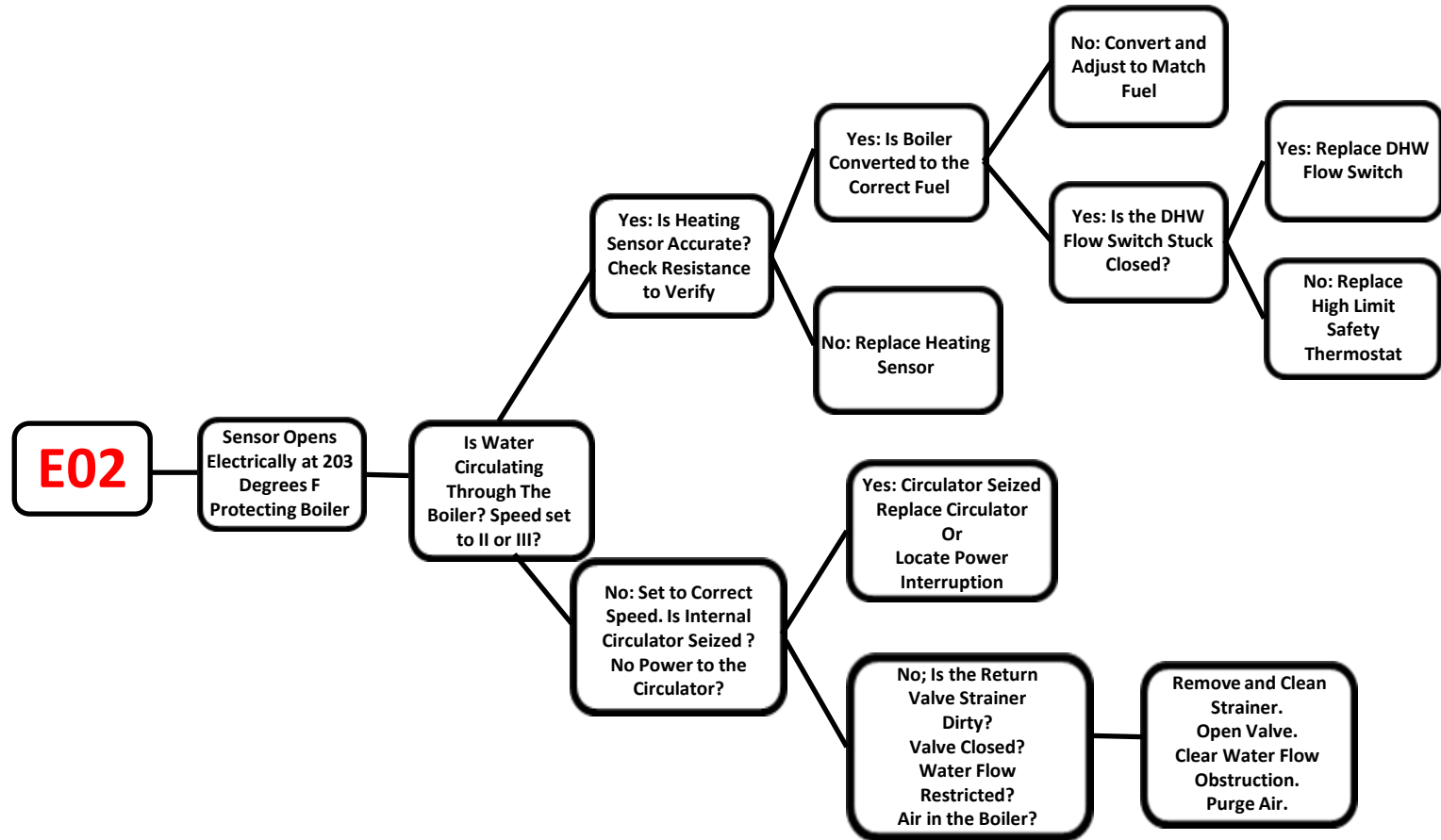

E02 High Limit Safety Thermostat



1. No Water Circulation Through Boiler

Verify that the internal circulator is operating correctly during both a heat and domestic hot water call. The circulator will operate immediately upon either demand. If the circulator is not operating check for the proper voltage (120 Volts AC) at the circulator power cable. If no power is measured, check the cable and its connection to the MPCB. If there is power at the MPCB and not at the circulator end of the cable, replace the cable. If no power exists at the MPCB circulator terminals, replace the MPCB.

If power is present at the circulator, but it does not function, test to determine if it is seized. First, disconnect power to the boiler. Secondly, place towels below the circulator and protect the control board from leaking water. Remove the nickel sized plug from the circulator motor and insert a narrow flat screwdriver into the hole. The end of the rotor shaft has an indentation that will accept the screwdriver. Attempt to turn the rotor. If it spins freely, yet the circulator won't function, replace the circulator. If the rotor is stuck, attempt to free it by turning the screwdriver back and forth several times. If it cannot be turned, replace the circulator. If it can be turned, replace the plug, **purge any air from the heat exchanger**, dry the area and remove the towels. Restore power to the boiler and verify proper circulator operation. Speed must be set to II or III.

When performing the screwdriver test, if the circulator spins, but with a lot of effort, or spins easily for part of its rotation then hard, replace the circulator. The circulator will likely be turning off on its internal thermal overload causing intermittent boiler flow issues.



Plug

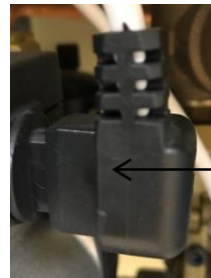

Power Cable

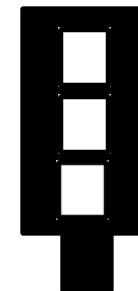

120 Volts AC

2. Heating Sensor Accuracy (NTC Sensor)

Disconnect power to the boiler and remove the heating sensor from the pipe. Disconnect the two wires and place the sensor in an area in which the ambient temperature can be measured. After allowing adequate time for the sensor temperature to stabilize, check the resistance across the two terminals and record both the Ohms reading and ambient temperature. Use the table on the following page to determine the accuracy of the sensor. If the ohms reading and temperature recorded match the information in the table, the heating sensor is good. If not, replace it.



Heating Sensor Secured With Spring Clip to Pipe

E02 High Limit Safety Thermostat

Visually inspect the heating sensor. If it is wet, or there are indications that it had been wet, replace it. NTC sensors are very susceptible to water damage. Inspect the o-ring above the sensor where the copper pipe enters the heat exchanger for leakage. Replace the o-ring if indications of a leak exist.

Temp	R	NTC	Temp	R	NTC	Temp	R	NTC	Temp	R	NTC	Temp	R	NTC
-20		105769	17.5		38780	55.5		15912	93		7196	131		3538
-18		100544	19		37079	57		15289	95		6944	133		3428
-16.6		95605	21		35463	59		14694	97		6702	134.5		3319
-14.8		90934	23		33925	61		14126	98.5		6470	136.5		3216
-13		86518	25		32461	62.5		13582	100		6247	138		3115
-11		82339	27		31069	64.5		13062	102		6033	140		3021
-9		78384	28.5		29743	66		12565	104		5828	142		2928
-7.5		74641	30		28481	68		12090	106		5630	143.5		2839
-6		71097	32		27279	70		11634	107.5		5440	145.5		2753
-4		67739	34		26136	71.5		11199	108.5		5258	147		2669
-2		64571	35.5		25044	73.5		10781	111		5082	149		2589
0		61563	37		24004	75		10382	113		4933	151		2512
1.5		58719	39		23014	77		9999	115		4751	152.5		2437
3		56016	41		22069	79		9633	116.5		4590	154.5		2365
5		53432	43		21168	80.5		9281	118.5		4444	156		2292
7		51018	45		20309	82.5		8945	120		4300	158		2229
9		48707	46.5		19489	84		8622	122		4161	160		2164
10		46513	48		18708	86		8313	124		4026	162		2101
12		44429	50		17959	88		8016	125.5		3897	163.5		2040
14		42449	52		17245	89.5		7731	127.5		3773	165		1982
16		40568	53.5		16563	91.5		7458	129		3653	167		1925

Alternate Test Method

Using an electronic temperature tester with pipe surface sensor, one can verify the accuracy of the heating sensor. Simply attach the test meters sensor to the pipe in the vicinity of the heating sensor. Operate the boiler. Compare the temperature displayed on the boilers LED control against that of the electronic meter. If the temperatures are the same then the heating sensor is good. If there is a several degree difference, replace the heating sensor.

E02 High Limit Safety Thermostat

3. Verify the Boiler is Operating on the Correct Fuel

If the boiler fuel conversion was done improperly, or not at all, the boiler may be grossly over-fired. Check the controls Parameter P02 - 'Selects the Type of Gas Supply' and verify the correct gas is selected (refer to the installation manual sections 5.1 and 5.2). Correct if necessary. Using an electronic combustion analyzer check the high fire CO₂ from a flue gas sample. Determine that it matches the values in the table on page 20. If the value is too high, using a 4mm Allen wrench, turn the V-screw clockwise to reduce. If too low, turn it counter-clockwise until the correct value is obtained.

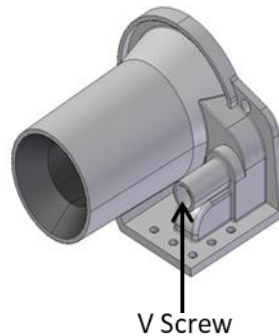

4. Domestic Hot Water Flow Switch not Operating Properly

Verify that the burner switches off when there is no demand for domestic hot water. If not the case, remove the micro-flow switch from the housing by removing the two screws. If the burner did not switch off, remove the two black wires of the flow switch from the MPCB. If the burner switched off, replace the flow switch. If the burner remains on, replace the MPCB.

Important: On PCI boilers, the internal indirect water tanks maintain temperature. Be sure to verify the tank is up to temperature when performing the flow switch test.



E02 High Limit Safety Thermostat

5. High Limit Safety Thermostat

Disconnect power to the boiler. Verify that the boiler has cooled. Remove the two wires from the High Limit Safety Switch. By means of an Ohms meter check for continuity across the switch. In the case of no continuity, replace the thermostat.



6. Return Valve Strainer

Disconnect power to the boiler. Shut off the water supply to the boiler. Isolate the boiler by shutting the heating supply and return valves. Drain the boiler by loosening the fitting between the return valve and boiler. Collect water in a bucket. Remove the strainer access nut and strainer. Clean strainer with warm water and nylon brush. Replace and tighten strainer access nut and the fitting between the return valve and boiler. Turn the water supply on and inspect for leaks. Pressurize the boiler and **purge any air** that may have been introduced. Restore power to the boiler and check for proper operation. **If the return valve is found to be installed on the supply side of the boiler it must be relocated to the return side (below circulator) immediately.**



7. Restriction in Boiler Piping

Verify that all valves are in the open position. Sediment collecting devices, such as a ywe strainers and dirt separators, have been cleaned and inspected.

8. Boiler Obstruction

If boiler is found to be plugged with contaminants and/or scale it will need to be flushed using products suitable for the boilers internal components. Consult the product manufacturer for suitability and directions.

E03 Flue Temperature Thermo-Fuse



Flue Temperature Thermo-Fuses are one-time blow fuses, non-resettable. Problem must be located and corrected before a new fuse is installed.

To perform troubleshooting procedures for this error code, the thermo-fuse circuit may need to be jumped out.
Warning: Be prepared to turn the boiler off immediately should a boiling sound occur within the heat exchanger.
Continued operation will damage the main heat exchanger!

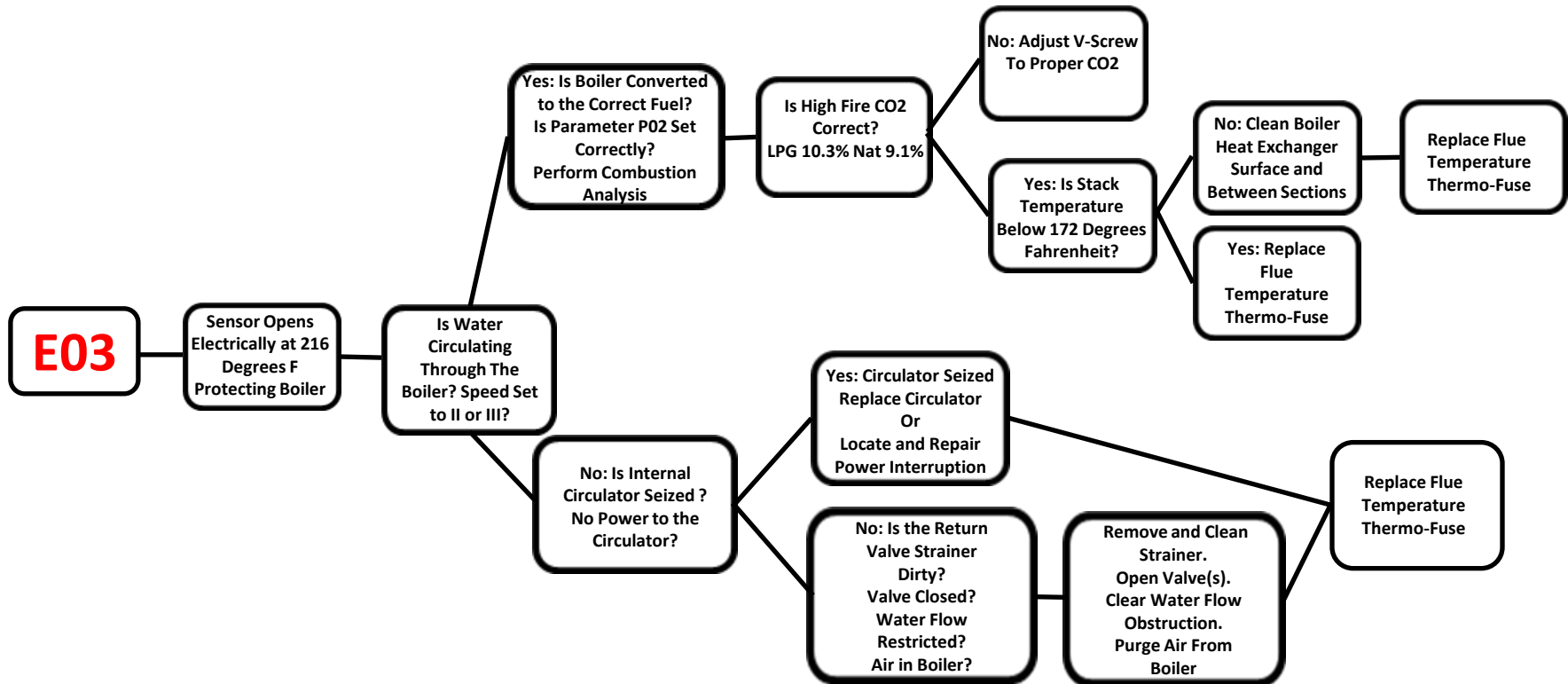

E03 Flue Temperature Thermo-Fuse

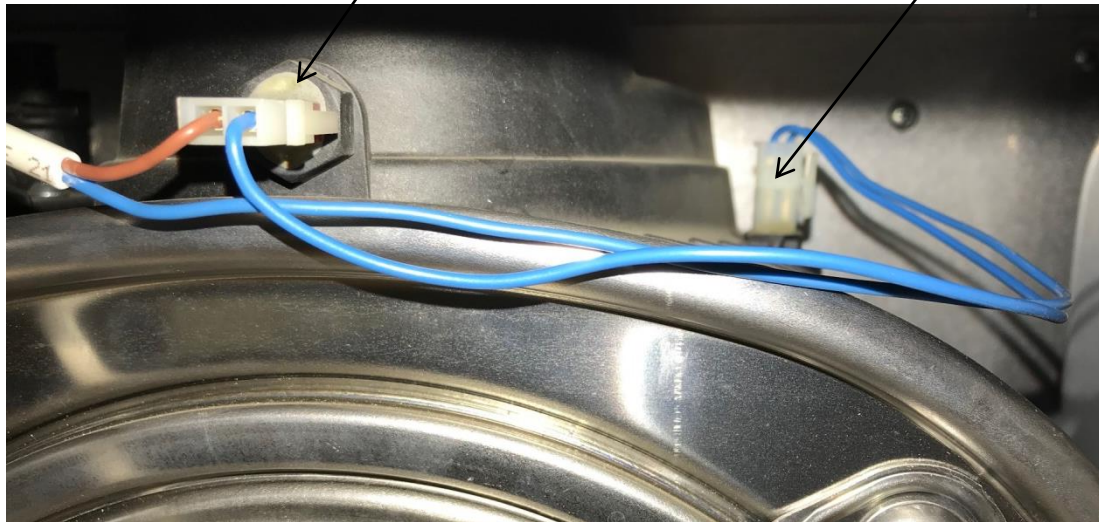
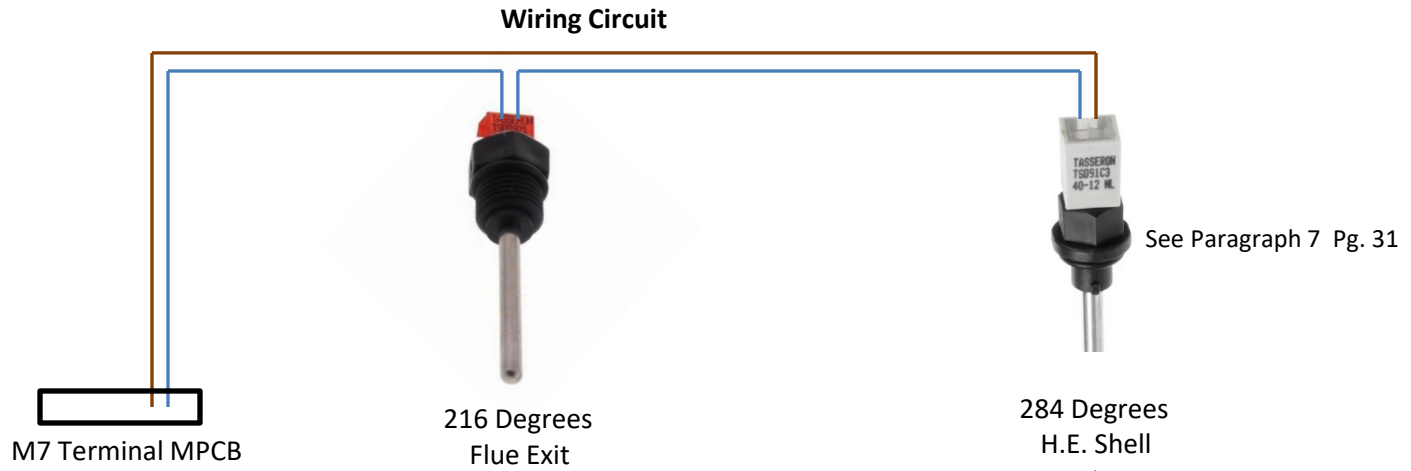

E03 Flue Temperature Thermo-Fuse

1. No Water Circulation Through Boiler

Verify that the internal circulator is operating correctly during both a heat and domestic hot water demand. The circulator will operate immediately upon either demand. If the circulator is not operating check for the proper voltage (120 Volts AC) at the circulator power cable. If no power is measured check the cable and its connection to the MPCB. If there is power at the MPCB and not at the circulator end of the cable, replace the cable. If no power exists at the MPCB circulator terminals, replace the MPCB.

If power is present at the circulator, but it doesn't function, test to determine if it seized. First, disconnect power to the boiler. Secondly, place towels below the circulator and protect the control board from leaking water. Remove the nickel sized plug from the circulator motor and insert a narrow flat screwdriver into the hole. The end of the rotor shaft has an indentation that will accept the screwdriver. Attempt to turn the rotor. If it spins freely, yet the circulator won't function, replace the circulator. If the rotor is stuck, attempt to free it by turning the screwdriver back and forth several times. If it cannot be turned, replace the circulator. If it can be turned, replace the plug, **purge any air from the heat exchanger**, dry the area and remove the towels. Restore power to the boiler and verify proper circulator operation. Speed must be set to II or III.

When performing the screwdriver test, if the circulator spins, but with a lot of effort, or spins easily for part of its rotation then hard, replace the circulator. The circulator will likely be turning off on its internal thermal overload causing intermittent boiler flow issues.



Plug

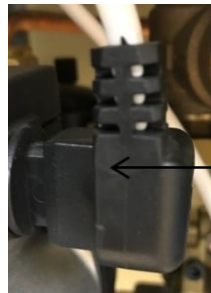

Power Cable



120 Volts AC

2. Verify the Boiler is Operating on the Correct Fuel

If the boiler fuel conversion was done improperly, or not at all, the boiler may be grossly over-fired. Check the controls Parameter P02 - 'Selects the Type of Gas Supply' and verify the correct gas is selected (refer to the installation manual sections 5.1 and 5.2). Correct if necessary. Using an electronic combustion analyzer, check the high fire CO2 from a flue gas sample. Determine that it matches the values in the table on page 20. If the value is too high, using a 4mm Allen wrench, turn the V-screw clockwise to reduce. If too low, turn it counter-clockwise until the correct value is obtained.

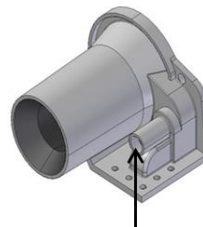

V Screw

E03 Flue Temperature Thermo-Fuse

3. Flue Gas Stack Temperature is Above 172 Degrees F.

If the boiler's flue gas temperature is above 172 degrees F., the primary heat exchanger must be cleaned. **Disconnect power to the boiler and shut the gas cock before cleaning. Electrical components must be protected. Protect the refractory within the heat exchanger. Wear proper personnel protective equipment.** Using a nylon brush and vacuum, clean the surface and between the sections of the heat exchanger. The majority of the heat exchanger's surface area lies between the sections. As such, it is imperative that this area be cleaned thoroughly and any restrictive deposits removed. Use a credit card thick plastic object to verify the flue gas passageways between the sections are clear. If the brush and vacuum does not clean the heat exchanger thoroughly, a light water spray can be used along with the nylon brush to loosen deposits. The water should pass between the sections, unrestricted, upon completion. If hard deposits still remain on or between the sections, CLR Cleaner in a spray bottle can be used to assist in their removal. Spray the CLR on the heat exchanger surface and allow it to penetrate the deposits. Do not allow the surface to dry. Brush the area and then flush the heat exchanger and condensate system thoroughly with clean water.

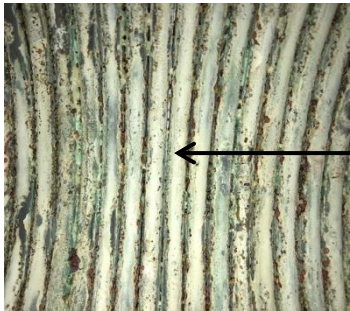

Dirty and Plugged H.E.

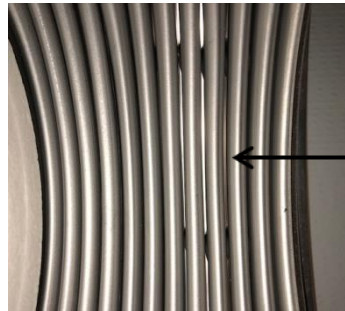

Open Flue Gas Passageways in H.E.



4. Return Valve Strainer

Disconnect power to the boiler. Shut off the water supply to the boiler. Isolate the boiler by shutting the heating supply and return valves. Drain the boiler by loosening the fitting between the return valve and boiler. Collect water in a bucket. Remove the strainer access nut and strainer. Clean strainer with warm water and nylon brush. Replace and tighten strainer access nut and the fitting between the return valve and boiler. Turn the water supply on and inspect for leaks. Pressurize the boiler and **purge any air** that may have been introduced. Turn the boiler on and check for proper operation. **If the return valve is found to be installed on the supply side of the boiler it must be relocated to the return side (below circulator) immediately.**



E03 Flue Temperature Thermo-Fuse

5. Restriction in Boiler Piping

Verify that all valves are in the open position. Sediment collecting devices, such as wye strainers and dirt separators, have been cleaned and inspected.

6. Boiler Obstruction

If boiler is found to be plugged with contaminants and/or scale it will need to be flushed using products suitable for the boiler's internal components. Consult the product manufacturer for suitability and directions.

7. Secondary Thermo-Fuse is Blown

Verify the thermo-fuse is blown. It can be accessed through the two pipe air intake opening on the top of the boiler. Remove the 4 Philip head screws that retain the cover. Disconnect the Molex wire connector from the fuse. This fuse has a ¼ turn receptacle, turn counter-clockwise to remove. Using an Ohms meter, check across the fuse's two terminals for continuity. An open circuit (no continuity) indicates a blown fuse.

Please contact Pensotti if this problem is detected. This fuse being blown, is potentially, a serious problem. The heat exchanger manufacturer recommends replacement of the main heat exchanger should this situation occur. This fuse is not offered as an independent replacement part.

E04 Low Water Pressure – Heating Circuit

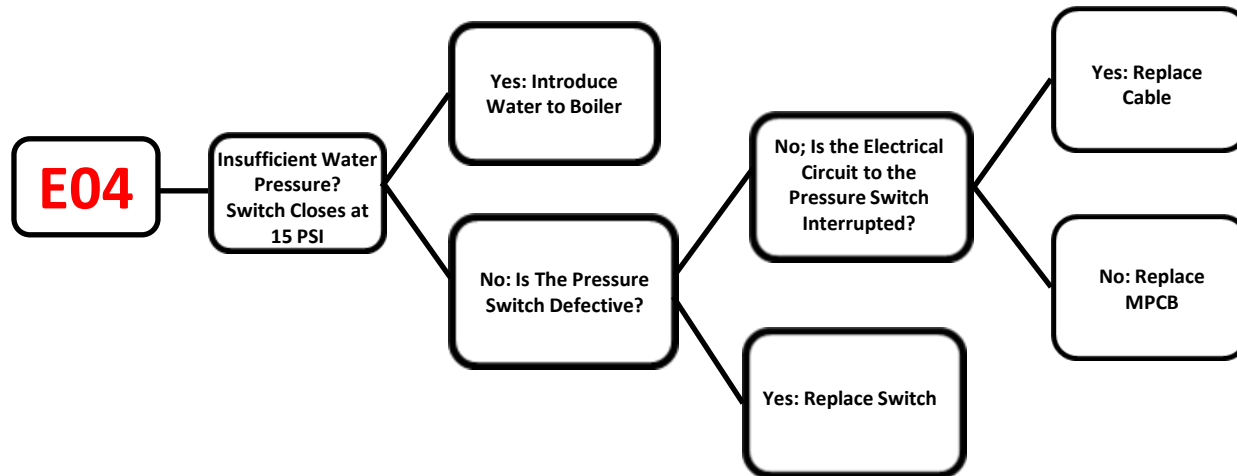
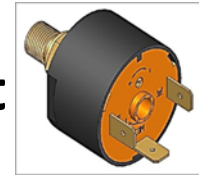

E04 Low Water Pressure – Heating Circuit

1. Insufficient Water Pressure in the Heating Circuit

The pressure switch will close electrically at approximately 15 psi. Introduce water through the pressure reducing valve until the pressure switch makes an audible click (switch closing) and E04 error code is disabled on the LED screen. Increasing the automatic fill pressure on the pressure reducing valve may be necessary.

Common causes of water pressure drop:

- Water leaks
- Air vent leaks
- Expansion tank air low or depleted (air pressure 15-17 psi)

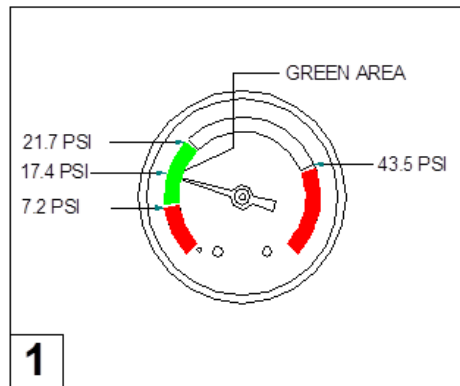

2. Defective Pressure Switch

Disconnect power to the boiler. Disconnect the cable from the pressure switch. Using a piece of insulated wire jump the two cable ends together. Restore power to the boiler. If the E04 error code is no longer displayed replace the pressure switch. If the E04 error remains illuminated, continue to step 3.

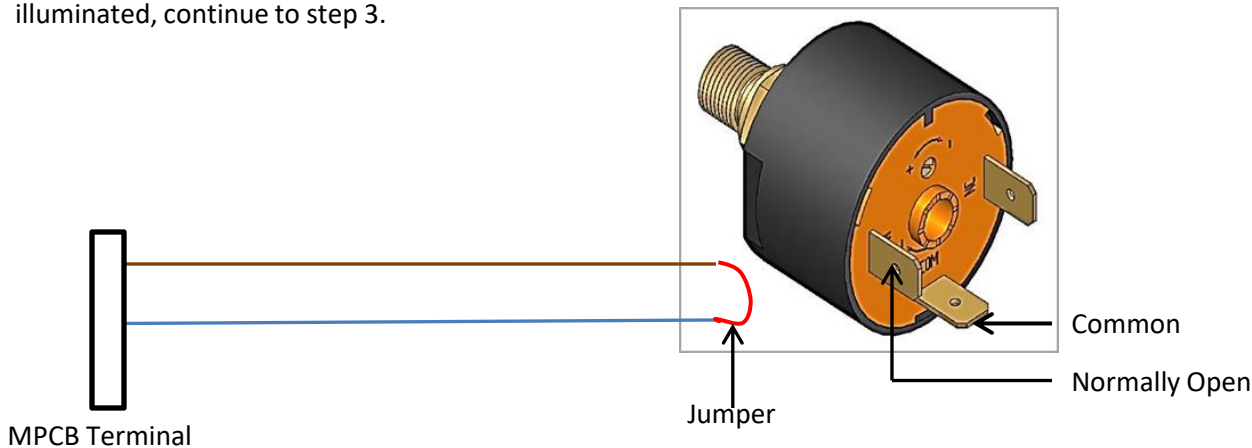

E04 Low Water Pressure – Heating Circuit

3. Defective Pressure Switch Cable

Disconnect power to the boiler. Using an Ohms meter verify the continuity of the two wires from the MPCB to the Pressure switch.

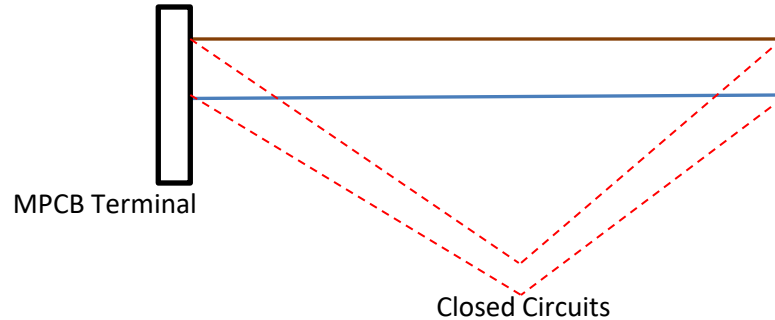

If one or both of the wires have an open circuit, replace the cable. If the two wires are found to be in good repair, replace the MPCB.

E05 Heating Sensor Circuit

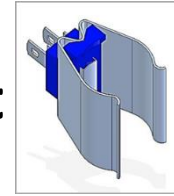

The E05 error code is enabled by either an open or shorted circuit to the NTC Heating Sensor

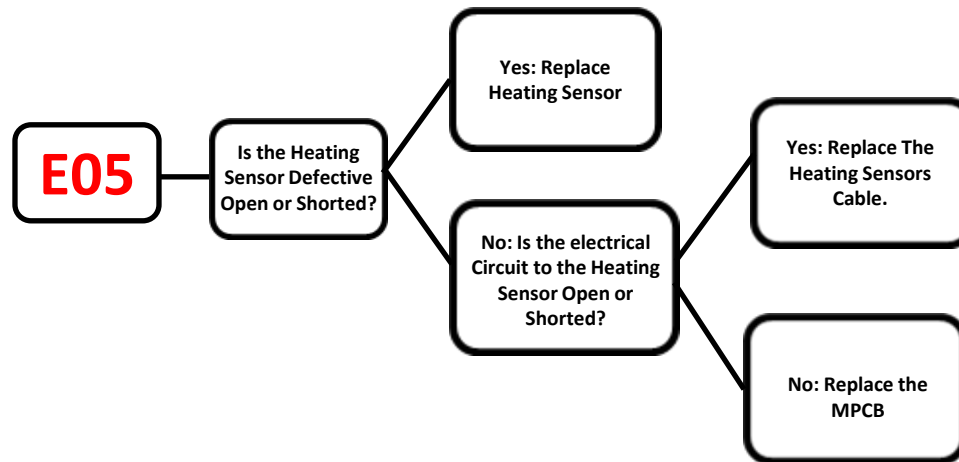

E05 Heating Sensor Circuit

1. Heating Sensor is Defective

Disconnect power to the boiler. Disconnect the cables from the heating sensor. Using an Ohm meter, check the resistance across the sensor. If the resistance is found to be infinity (open circuit) or closed (shorted circuit) replace the heating sensor. If the ohms meter is measuring a resistance you can verify the accuracy of the heating sensor by using the table below. Measure the temperature which the sensor is detecting, locate that temperature on the table and verify that the Ohms reading coincides. If a wide variance is detected, replace the heating sensor. Once the defect is corrected the E05 error code will automatically reset.

Visually inspect the heating sensor. If it is wet, or there are indications that it had been wet, replace it. NTC sensors are very susceptible to water damage. Inspect the o-ring above the sensor where the copper pipe enters the heat exchanger for leakage. Replace the O-ring if indications of a leak exist.

Temp	R	NTC	Temp	R	NTC	Temp	R	NTC	Temp	R	NTC	Temp	R	NTC
-20	105769		17.5	38780		55.5	15912		93	7196		131	3538	
-18	100544		19	37079		57	15289		95	6944		133	3428	
-16.6	95605		21	35463		59	14694		97	6702		134.5	3319	
-14.8	90934		23	33925		61	14126		98.5	6470		136.5	3216	
-13	86518		25	32461		62.5	13582		100	6247		138	3115	
-11	82339		27	31069		64.5	13062		102	6033		140	3021	
-9	78384		28.5	29743		66	12565		104	5828		142	2928	
-7.5	74641		30	28481		68	12090		106	5630		143.5	2839	
-6	71097		32	27279		70	11634		107.5	5440		145.5	2753	
-4	67739		34	26136		71.5	11199		108.5	5258		147	2669	
-2	64571		35.5	25044		73.5	10781		111	5082		149	2589	
0	61563		37	24004		75	10382		113	4933		151	2512	
1.5	58719		39	23014		77	9999		115	4751		152.5	2437	
3	56016		41	22069		79	9633		116.5	4590		154.5	2365	
5	53432		43	21168		80.5	9281		118.5	4444		156	2292	
7	51018		45	20309		82.5	8945		120	4300		158	2229	
9	48707		46.5	19489		84	8622		122	4161		160	2164	
10	46513		48	18708		86	8313		124	4026		162	2101	
12	44429		50	17959		88	8016		125.5	3897		163.5	2040	
14	42449		52	17245		89.5	7731		127.5	3773		165	1982	
16	40568		53.5	16563		91.5	7458		129	3653		167	1925	

E05 Heating Sensor Circuit

2. Defective Sensor Cable

Disconnect power to the boiler. Disconnect the cables from the heating sensor. Verify the continuity of the cables from the MPCB to the sensor terminals. If the circuit is closed on both cables then they are good. If the circuit is open on either cable, the cable is defective. Replace the cable, reconnect the heating sensor and the E05 error code will automatically reset.

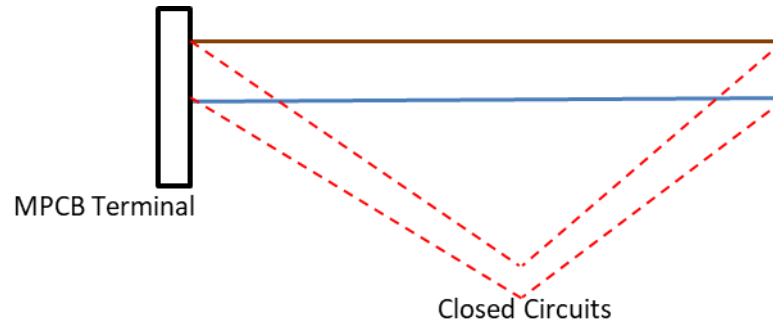

3. Defective MPCB

If both the heating sensor and cables tests verify proper operation, replace the MPCB.

E06 Domestic Hot Water Sensor Circuit

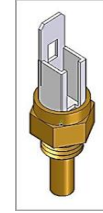

The E06 error code is enabled by either an open or shorted circuit to the NTC Domestic Hot Water Sensor

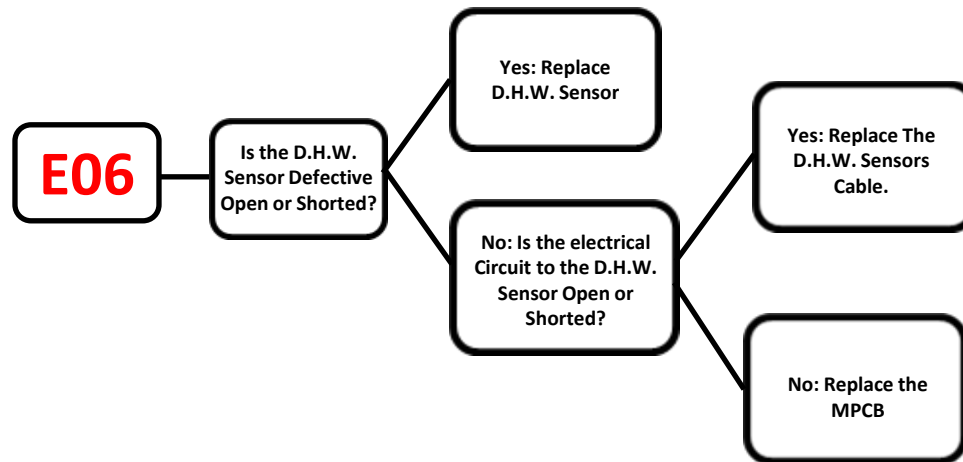

E06 Domestic Hot Water Sensor Circuit

1. D.H.W. Sensor is Defective

Disconnect power to the boiler. Disconnect the cables from the D.H.W. sensor. Using an Ohm meter check the resistance across the sensor. If the resistance is found to be infinity (open circuit) or closed (shorted circuit) replace the D.H.W. sensor. If the ohms meter is measuring a resistance, you can verify the accuracy of the heating sensor by using the table below. Measure the temperature which the D.H.W. sensor is detecting, locate that temperature on the table and verify that the Ohms reading coincides. If a wide variance is detected, replace the sensor. Once the defect is corrected the E06 error code will automatically reset.

Visually inspect the D.H.W. sensor. If it is wet, or there are indications that it had been wet in the past, replace it. NTC sensors are very susceptible to water damage.

Temp	R NTC	Temp	R NTC	Temp	R NTC	Temp	R NTC	Temp	R NTC	Temp	R NTC
-20	105769	17.5	38780	55.5	15912	93	7196	131	3538	169	1870
-18	100544	19	37079	57	15289	95	6944	133	3428	171	1817
-16.6	95605	21	35463	59	14694	97	6702	134.5	3319	172.5	1766
-14.8	90934	23	33925	61	14126	98.5	6470	136.5	3216	174	1717
-13	86518	25	32461	62.5	13582	100	6247	138	3115	176	1669
-11	82339	27	31069	64.5	13062	102	6033	140	3021	178	1622
-9	78384	28.5	29743	66	12565	104	5828	142	2928	179.5	1577
-7.5	74641	30	28481	68	12090	106	5630	143.5	2839	181.5	1534
-6	71097	32	27279	70	11634	107.5	5440	145.5	2753	183	1491
-4	67739	34	26136	71.5	11199	108.5	5258	147	2669	185	1451
-2	64571	35.5	25044	73.5	10781	111	5082	149	2589	187	1411
0	61563	37	24004	75	10382	113	4933	151	2512	189	1373
1.5	58719	39	23014	77	9999	115	4751	152.5	2437	190.5	1228
3	56016	41	22069	79	9633	116.5	4590	154.5	2365	192	1300
5	53432	43	21168	80.5	9281	118.5	4444	156	2292	194	1266
7	51018	45	20309	82.5	8945	120	4300	158	2229	196	1232
9	48707	46.5	19489	84	8622	122	4161	160	2164	197.5	1199
10	46513	48	18708	86	8313	124	4026	162	2101	199.5	1168
12	44429	50	17959	88	8016	125.5	3897	163.5	2040	201	1137
14	42449	52	17245	89.5	7731	127.5	3773	165	1982	203	1109
16	40568	53.5	16563	91.5	7458	129	3653	167	1925	205	1079

E06 Domestic Hot Water Sensor Circuit

2. Defective Sensor Cable

Disconnect power to the boiler. Disconnect the cables from the D.H.W. sensor. Verify the continuity of the cables from the MPCB to the sensor terminals. If the circuit is closed on both cables then they are good. If the circuit is open on either cable, the cable is defective. Replace the cable, reconnect the D.H.W. sensor and the E06 error code will automatically reset.

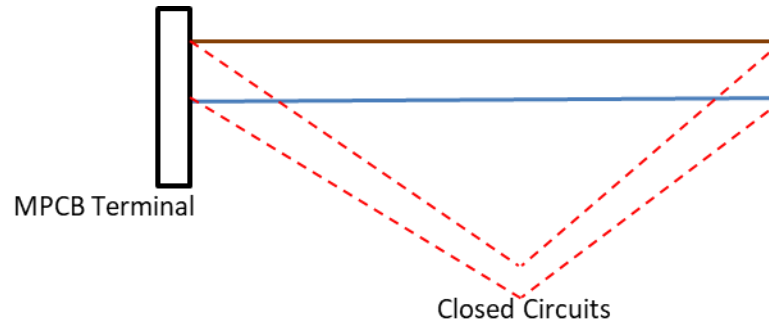

3. Defective MPCB

If both the D.H.W. sensor and cables tests verify proper operation. Replace the MPCB.

E16 Combustion Fan Failure

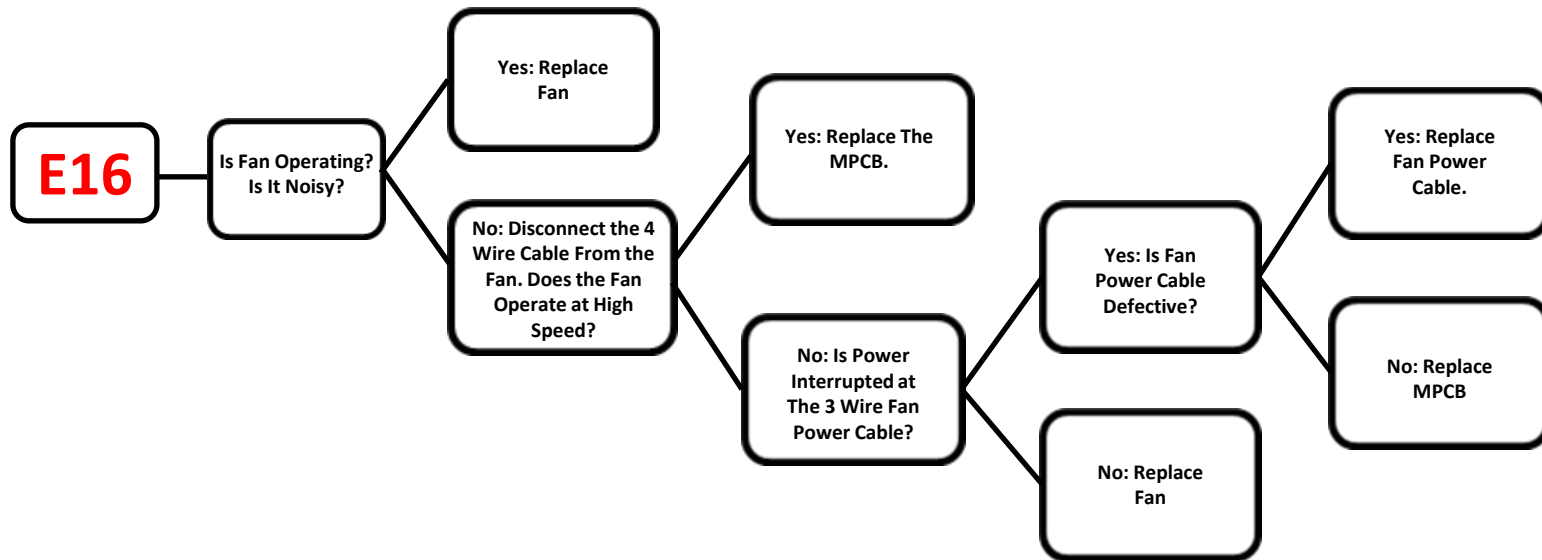
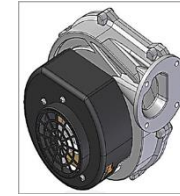

E16 Combustion Fan Failure

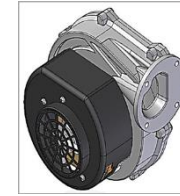

1. Combustion Fan Noisy

Disconnect power to the boiler. Shut the gas cock. Remove and replace the fan. Refer to Section 6.7 in the installation manual for instructions.

2. Combustion Fan Not Operating

Shut the gas cock. Leave the boiler powered on. Turn the power switch to the off position. Disconnect the 4 wire communication cable to the fan, the fan should immediately operate at high speed. If so, the fan is good. Replace the MPCB.

If the fan did not operate when the 4 wire cable was disconnected, remove the 3 wire power cable from the fan. Using a multi-meter, check for 120 Volts AC at the blue and brown terminals of the cable connector. If power is present, replace the fan. If power is not present, inspect the cable for damage. If damaged, replace the cable. If not damaged, follow the cable back to the MPCB and check for 120 Volts AC at the MPCB terminals, Molex connector M10. If power is present, replace the cable. If there is no power at the MPCB Fan cable terminals, replace the MPCB.

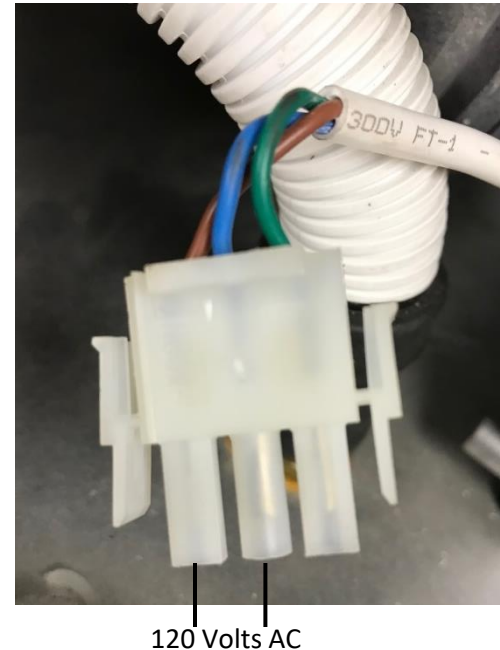
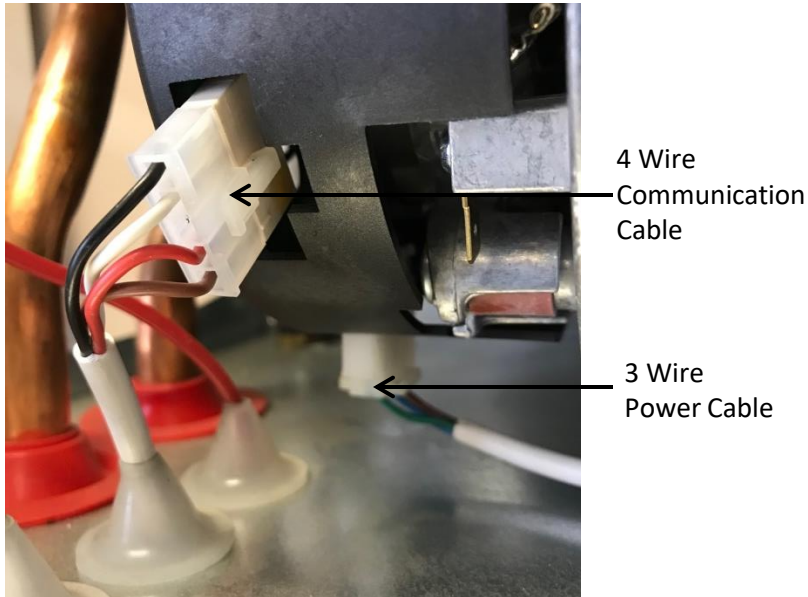

E18 Inadequate Boiler Water Circulation

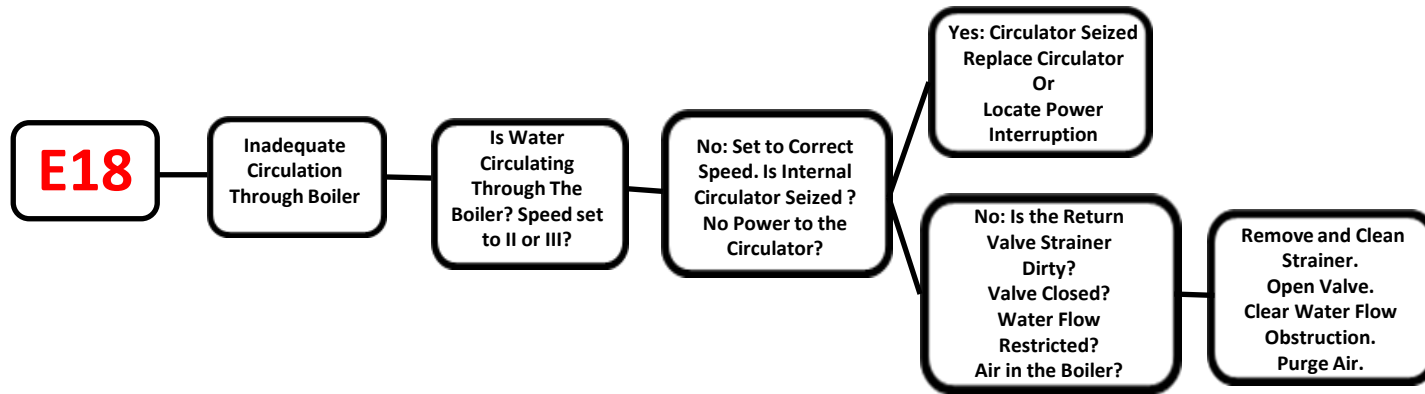

E18 Inadequate Boiler Water Circulation

1. No or Reduced Water Circulation Through Boiler

Verify that the internal circulator is operating correctly during both a heat and domestic hot water demand. Verify that the speed switch is set to either II or III. The circulator will operate immediately upon either demand. If the circulator is not operating check for the proper voltage (120 Volts AC) at the circulator power cable. If no power is measured, check the cable and its connection to the MPCB. If there is power at the MPCB and not at the circulator end of the cable, replace the cable. If no power exists at the MPCB circulator terminals, replace the MPCB.

If power is present at the circulator, but it doesn't function, test to determine if it seized. First, disconnect power to the boiler. Secondly, place towels below the circulator and protect the control board from leaking water. Remove the nickel sized plug from the circulator motor and insert a narrow flat screwdriver into the hole. The end of the rotor shaft has an indentation that will accept the screwdriver. Attempt to turn the rotor. If it spins freely, yet the circulator won't function, replace the circulator. If the rotor is stuck, attempt to free it by turning the screwdriver back and forth several times. If it cannot be turned, replace the circulator. If it can be turned, replace the plug, **purge any air from the heat exchanger**, dry the area and remove the towels. Restore power to the boiler and verify proper circulator operation. Speed must be set to II or III.



Plug



Cable
Connection

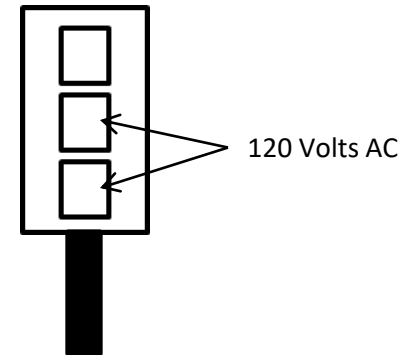

When performing the screwdriver test, if the circulator spins, but with a lot of effort, or spins easily for part of its rotation then hard, replace the circulator. The circulator will likely be turning off on its internal thermal overload causing intermittent boiler flow issues.

E18 Inadequate Boiler Water Circulation

2. Return Valve Strainer

Disconnect power to the boiler. Shut off the water supply to the boiler. Isolate the boiler by shutting the heating supply and return valves. Drain the boiler by loosening the fitting between the return valve and boiler. Collect water in a bucket. Remove the strainer access nut and strainer. Clean strainer with warm water and nylon brush. Replace and tighten strainer access nut and the fitting between the return valve and boiler. Turn the water supply on and inspect for leaks. Pressurize the boiler and **purge any air** that may have been introduced. Restore power to the boiler and check for proper operation. **If the return valve is found to be installed on the supply side of the boiler it must be relocated to the return side (below circulator) immediately.**

3. Boiler Obstruction

If boiler is found to be plugged with contaminants and/or scale it will need to be flushed using products suitable for the boiler's internal components. Consult the product manufacturer for suitability and directions.

4. Restriction in Boiler Piping

Verify that all valves are in the open position. Sediment collecting devices, such as wye strainers and dirt separators, have been cleaned and inspected.



Return Valve With Strainer

E21 MPCB Malfunction

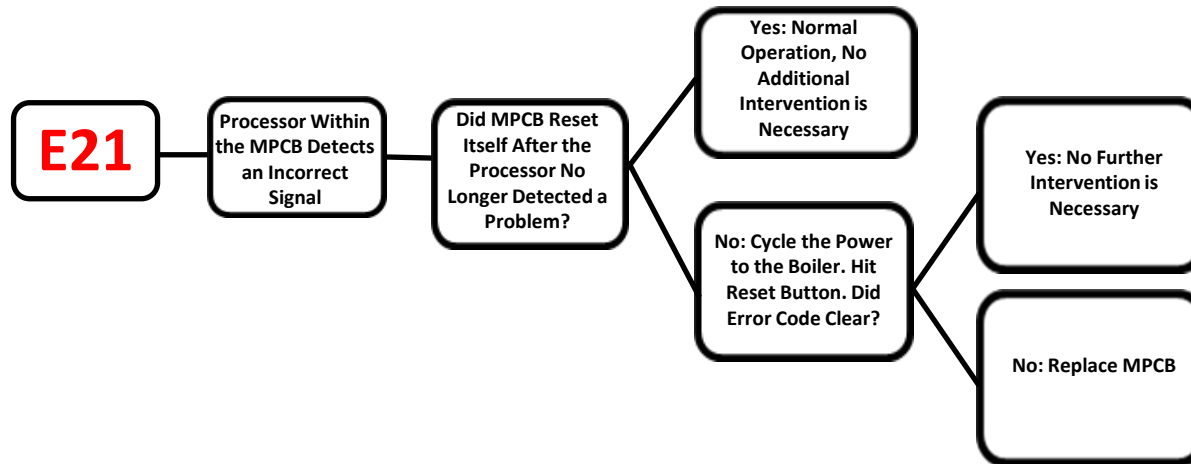

1. Typical Scenario

This error code typically goes undetected because the MPCB will automatically reset after the microprocessor detects that the information which enabled the error code has returned to normal. This process, typically, takes just several minutes.

2. Error Did Not Reset After Several Minutes

If the Error code has not automatically reset after several minutes, press the reset button. If pressing the reset button is not successful, cycle the power on and off to the boiler. If cycling the power proves unsuccessful, replace the MPCB.

E22 Parameters Need To Be Programmed

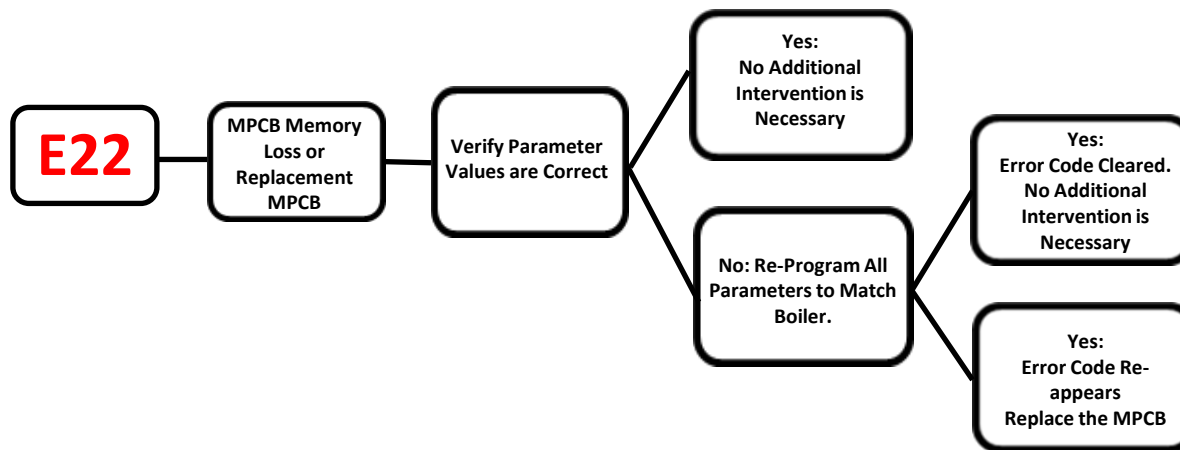

1. Loss of Microprocessor Memory

To reset the error code, cycle the power to the boiler on and off. Press the reset button.

Open the parameters value menu and verify the proper value for each parameter matches the boiler. Refer to the installation manual, section 5, 'regulating the appliance', for instructions. When completed, exit the parameters value menu and operate boiler. Verify proper operation.

2. E22 Error Code Re-appears

Replace the MPCB and program the parameters to match the boiler.

E35 Flame Ionization Circuit Malfunction

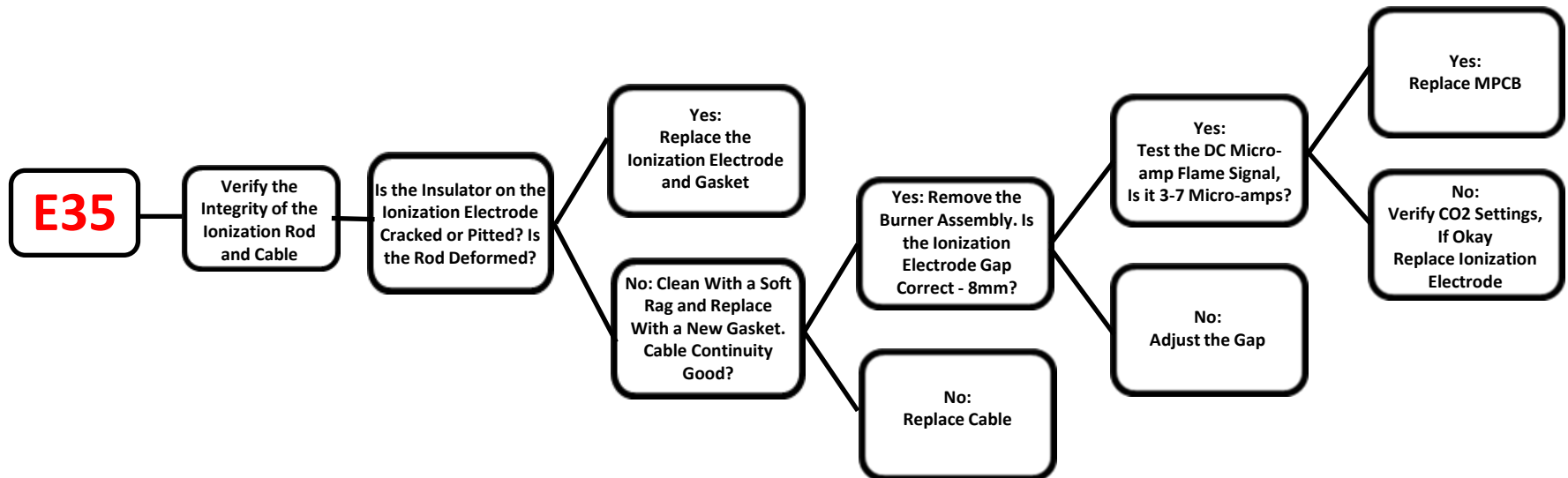
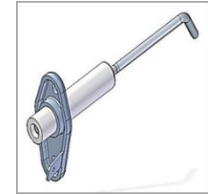

E35 Flame Ionization Circuit Malfunction

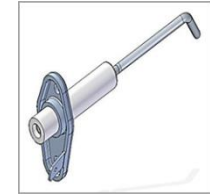

1. Verify The Condition of the Ionization Electrode

Disconnect power to the boiler. Shut off the gas cock. Remove the ionization electrode from the burner and inspect the electrode rod for deformity and the insulator for cracks and pitting. If damaged or broken, replace it using a new gasket. If undamaged, clean it with a soft rag only and re-install using a new gasket.

2. Ionization Electrode Cable

Disconnect power to the boiler. Shut off the gas cock. Inspect the cable for cracks or cuts to the insulation and the integrity of the cable end connectors. If damaged, replace it. If found to be undamaged, check the continuity of the cable with an Ohms meter to guaranty the cables integrity. If defective, replace it. Insure the cable ends provide a secure connection.

3. Ionization Electrode Gap

If the ionization electrode and cable are not broken, the electrode gap will need to be verified. With the power to the boiler disconnected and the gas cock shut off, disassemble the burner assembly to access the burner (reference the Instruction Manual section 6.7 for details). Using an 7mm Allen Wrench as a gauge, measure the gap between the electrode and surface of the burner. Adjust the gap if necessary, being careful not to break the electrode . Reassemble the burner, connect the cables and check for gas leaks before powering the boiler.

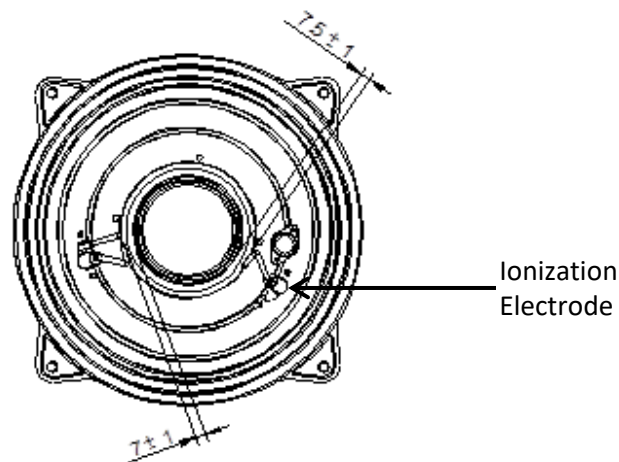

E35 Flame Ionization Circuit Malfunction

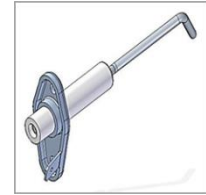

4. Check Flame Signal Strength

Disconnect power to the boiler. Using a DC micro-amp meter, check the flame signal strength. A normal reading is 3-7 micro-amps. The MPCB will lock out (generate an E01 Fault) with a flame signal of less than .5 micro-amps.

Insert the micro-amp meter in series between the Ionization Electrode and MPCB. Turn the boiler on and allow it to ignite, observe the reading on the meter for a moment. If using an analog meter and the value drops below 0, reverse the meters test leads. If the reading falls below the normal range listed above, replace the ionization electrode.

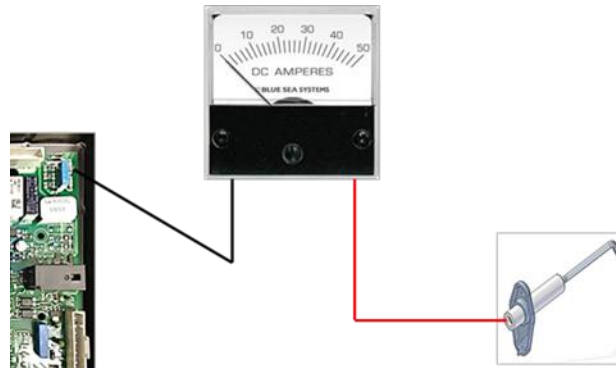

5. MPCB

If the micro-amp reading falls into the normal range, but the E35 error code is still being generated, replace the MPCB.

E40 Power Supply Out Of Range

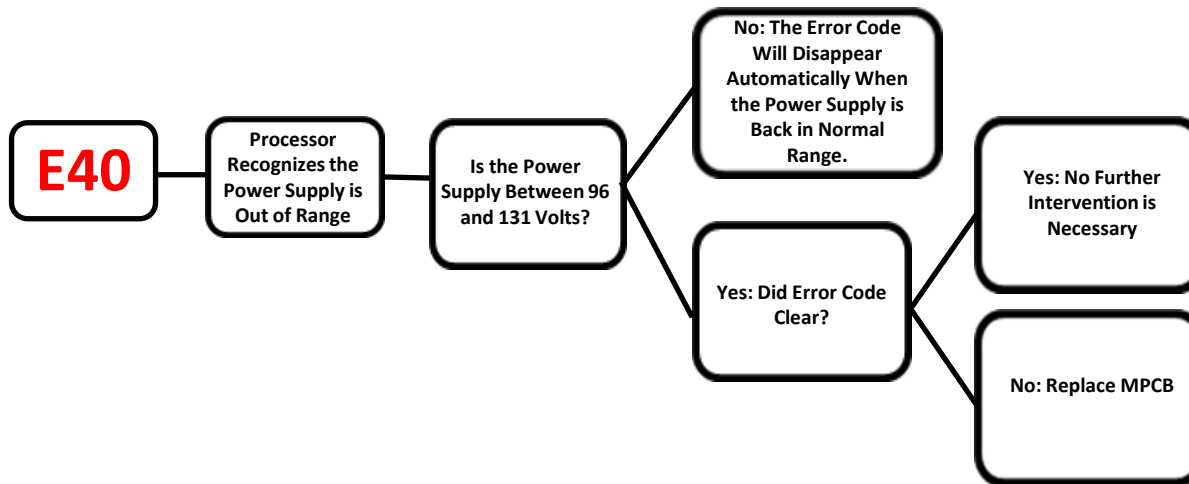

1. Power Supply

Using a multi-meter, measure the AC voltage supply to the boiler. Normal operating range for the MPCB is 96-131 volts. If the voltage is out of range, contact a licensed electrician to remedy the problem. Once the voltage is restored to the normal range, the error code will automatically reset.

2. Power Supply Within Normal Range

If the power supply is within the normal range and the error code has not automatically reset after several minutes, press the reset button. If pressing the reset button is not successful, cycle the power on and off to the boiler. If cycling the power proves unsuccessful, replace the MPCB.

F0_ Function Codes

Function Code F0_



A Function Code (F0_) displayed on the control is **not** an indication of a boiler fault. Its providing notification that one of the Function Modes is activated, either manually or automatically.

F0_ Function Codes

Function Code	Description	Enabled	Disabled
F07	Flue Test	Manually	Manually/Automatically
F08	Frost Protection- Heating Circuit	Automatically	Automatically
F09	Frost Protection- D.H.W. Circuit	Automatically	Automatically
F28	Legionella Protection	Automatically	Automatically
F33	Boiler Air Purging	Automatically	Automatically

F0_ Function Codes

Code	Description
F07	<p>Flue Test Function: Pressing the 'R' button for 7 seconds enables this test mode. The flue test function operates the boiler at high fire for 15 minutes without burner modulation. This function is primarily used for combustion testing. It can be disabled by waiting the 15 minutes or by turning the boiler off with the power-mode selection button. The most recent versions of the MPCB allows you to choose both high or low fire flue tests. Once in the Flue Test mode, pressing the Heating + button activates high fire, pressing the Heating – button activates low fire.</p>
F08	<p>Frost Protection-Central Heating: This function is automatically enabled when the heating sensor detects a temperature of 41 degree F. The boiler operates at low fire with the diverter valve in the heating position. The function is automatically disabled when the temperature detected by the heating sensor reaches 86 degree F. (Protects boiler only)</p>
F09	<p>Frost Protection-D.H.W.: This function is automatically enabled when the D.H.W. sensor detects a temperature of 39 degrees F. The boiler operates at low fire with the diverter valve in the D.H.W. position. The function is disabled when the D.H.W. sensor detects a temperature of 46 degree F, or the heating sensor detects 86 degrees F. (Protects boiler only)</p>
F28	<p>Legionella Protection: D.H.W. storage boilers only. Enabled on a 7 day cycle. It brings the water temperature of the D.H.W storage tank up to 140 degrees F, regardless of the tanks set point. Function can be permanently disabled within parameter P15.</p>
F33	<p>Boiler Air Purging: This function is automatically enabled before the first ignition sequence of a new boiler. The boiler operates a series of circulator cycles for a 5 minute period of time while disabling the boilers ability to fire. The pump operates 40 seconds on then 20 seconds off to assist in air removal. In the case of an E04 error code, low water pressure, this function will be enabled for a 2 minute period of time upon correction of the low water pressure problem. This function is designed to assist in the air removal process, manual air purging is still required.</p>

Low Fire CO2 Adjustment

Low Fire Co2 Adjustment Procedure

- Turn boiler off
- Turn all heating thermostats several degrees above room temperature
- Turn on the electronic combustion analyzer and set to the proper gas
- Turn boiler on and 'Heat' will be enabled (radiator flashing)
- Burner will fire
- Press and hold the reset button (R) until F07 appears on the screen.
- Burner will modulate to low fire and remain there for 15 minutes*
- Remove flue gas sampling port plug from the vent adapter
- Insert analyzers' sampling probe into the test port and secure
- Wait for CO2 reading to stabilize on the analyzer, then compare it to the values in the table below

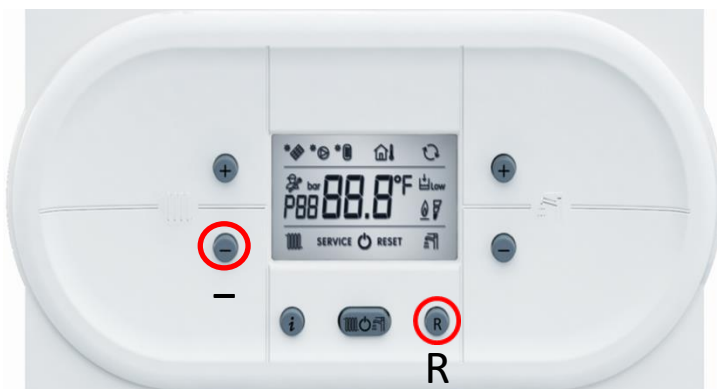

- If the values differ, the low fire CO2 will need to be adjusted

Boiler Model	Gas Type	CO ₂ %
PCH 34B	Nat	9.0
	LPG	10.1
PCH 50B	Nat	9.2
	LPG	10.1
PCC 34	Nat	9.0
	LPG	10.1
PCI 18/8	Nat	9.1
	LPG	9.8
PCI 34/20	Nat	9.0
	LPG	10.1

*If the boiler does not modulate to low fire upon pressing (R) button, press and release the heat temperature '–' button. If it still doesn't modulate to low fire you have an older version of the MPCB. This will require you to access parameter P12 'Minimum Fan Speed – Heating' to enable low fire operation. Once the parameter is accessed, the burner will fire and immediately go to low fire, staying there for 15 minutes before automatically disabling itself. See instruction manual 'Accessing the Parameters Menu' section for additional information.

Low Fire CO2 Adjustment

- Locate Low Fire adjustment screw cover on the gas valve and remove it with a T40 Torx bit. The adjustment screw is beneath.

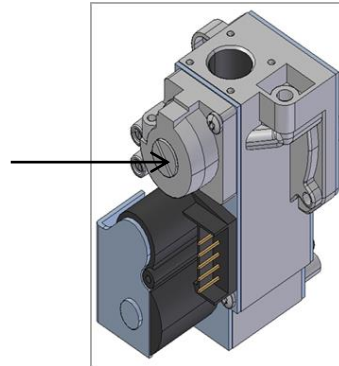

- Using the same T40 bit inserted into the adjustment screw, the Low Fire CO2 value can be adjusted. **This screw is extremely sensitive, make small incremental adjustments.** Turn the adjustment screw clockwise to increase the CO2 value, counter-clockwise to reduce. Adjust to match the value in the table on page 54.
- When finished, replace the adjustment screw cover
- Press the controls mode selection button to the off position to disable low fire. *
- Remove combustion analyzer probe from the test port and reinstall the test plug
- Turn the boiler on using the mode selection button
- Verify proper mode selection and boiler operation
- Return heating thermostats to their original settings

* Older versions of the control will require you to exit parameter P12 'Minimum Fan Speed – Heat' to disable low fire. Simultaneously press and hold both the 'i' and 'R' buttons until the control reverts back to the standard screen. See instruction manual for additional information.



Diverter Valve Operation



The diverter valve directs the boiler water to either the heating circuit or domestic hot water production circuit. When a demand is enabled, the MPCB will send 120 volts AC to either the heat circuit (black wire) or D.H.W. circuit (brown wire) of the diverter valve motor. Once the motor is in the proper position, a cam lobe on the motor shaft will open a micro-switch stopping the motor in the correct position. **The diverter valve does not have end switches to enable burner operation after it has turned to the proper position.** Operation of the circulator and burner is enabled through the MPCB.

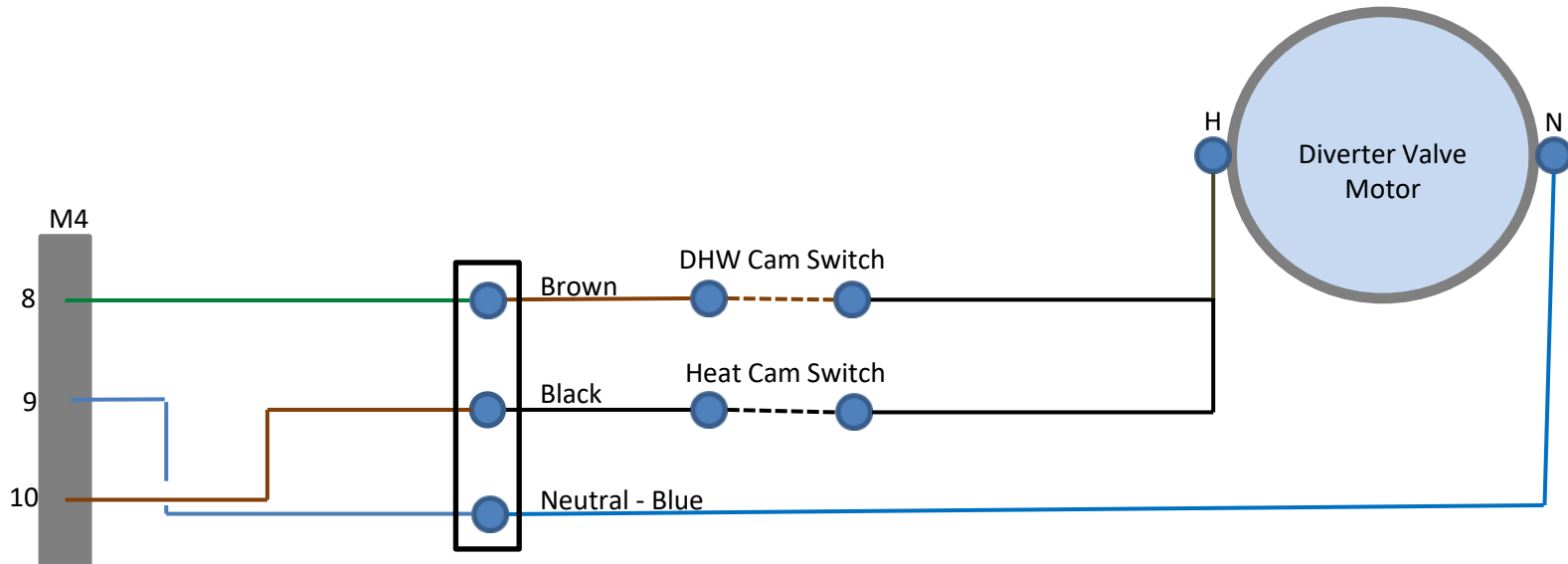

Heat Sequence:

Upon a call for heat; power is delivered from terminal #10 on the MPCB, through the cable, to the black wire of the diverter valve and through the closed heat cam switch. The motor rotates to the heat position until lobe on the motor shaft contacts the heat cam micro-switch, opening it, stopping the motor.

D.H.W. Sequence:

Upon a call for D.H.W.; power is delivered from terminal #8 on the MPCB, through the cable, to the brown wire of the diverter valve and through the closed D.H.W. cam switch. Motor rotates to the D.H.W. position until the lobe on the motor shaft contacts the D.H.W. cam micro-switch, opening it, stopping the motor.

Diverter Valve Operation

Internal Boiler Water Flow Path through the Diverter Valve

Boiler Water Heating Flow Path

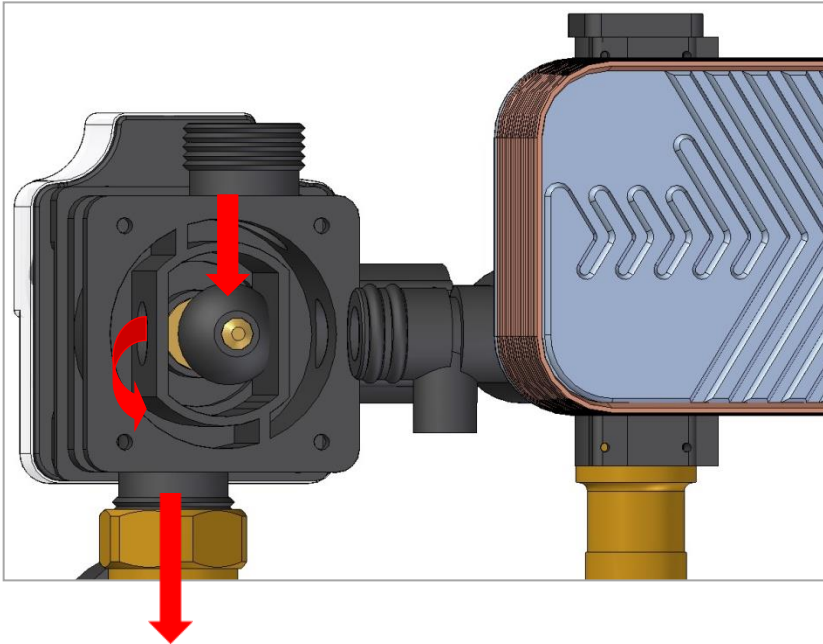

To Boiler Heating Circuit Supply

Boiler Water D.H.W. Flow Path

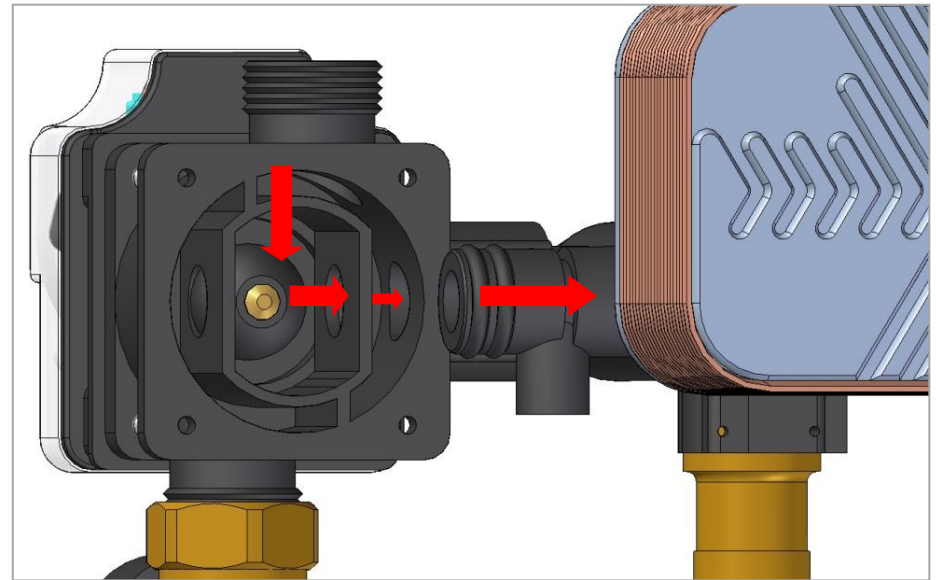

To Brazed Plate Heat Exchanger
or Indirect Water Heater

Diverter Valve Operation

Diverter valve operation can be observed through the aid of the position indicator located behind the motor.

1. Check for Correct Operation

Disconnect power to the boiler. Swing control panel down. Removal of the right hand side panel will assist in accessing the diverter valve. Locate the valve and remove the clear plastic cover by removing the single Philips head screw, then pull the cover off the valve. Re-establish power to the boiler. Enable both heat and D.H.W. calls. Locate and observe the position indicator. Using the mode selection button on the control panel, cycle the boilers operation from heat to hot water. Observe indicator location when the motor stops. Indicator should be in the position illustrated in Fig. 1. Now, cycle the boiler from D.H.W. to heat. Again, observe the indicators position when the motor stops. Indicator should be in the position shown in Fig. 2. If so, the diverter valve is operating correctly.

2. Incorrect Operation, Noisy

If diverter does not operate as described above, or is found stuck between the heat and D.H.W. positions. If the valve is noisy as it turns, or a clicking noise is heard from the motor, replace the diverter valve motor actuator assembly.



Fig. 1 - Position Indicator – D.H.W. Production

Fig. 2 - Position Indicator – Heat Production

Diverter Valve Operation

3. Valve Continually Rotates (No Hot Water, Quick Intermittent Hot Water, Quick Intermittent Burner Cycling)

If the diverter valve is found to be continually rotating, a micro-switch has failed in the closed position. The diverter valve motor actuator assembly will need to be replaced.

4. Diverter Valve Motor Actuator Replacement

Disconnect power to the boiler. Shut off the gas and water supply to the boiler. Isolate the boiler from the heating circuit piping and drain the water completely. Using dry rags, protect the adjacent components from water leakage. Separate the power cable from the diverter valve at the Molex connector. Using a long Philips head screwdriver, remove the four screws securing the motor actuator assembly to the valve body. Gently twist and pull the motor actuator assembly from the body absorbing any water that may not have drained out. Remove the red o-ring from the valve body and discard. Install the new red o-ring on the new motor actuator assembly and lubricate it with a small amount of water based lubricant. Install the replacement assembly into the valve body and verify the o-ring is properly seated. Secure with the four Philips head screws. Attach the wire cable to the new actuator assembly. Fill the boiler with water and **purge all accumulated air**. Re-open any valves that were closed to isolate the boiler. Inspect for and repair any water leaks. Reconnect power to the boiler and open the gas cock. Operate the boiler and verify proper operation (paragraph 1).

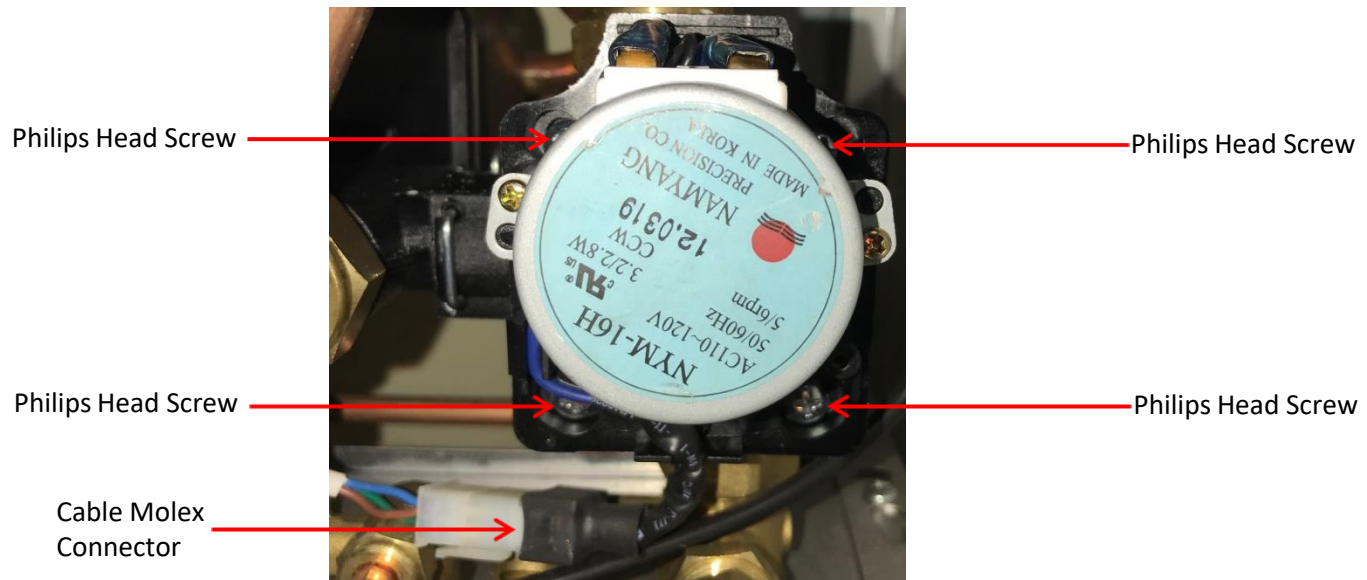

No Hot Water - Domestic Hot Water Flow Switch Operation

PCC and PCI Models

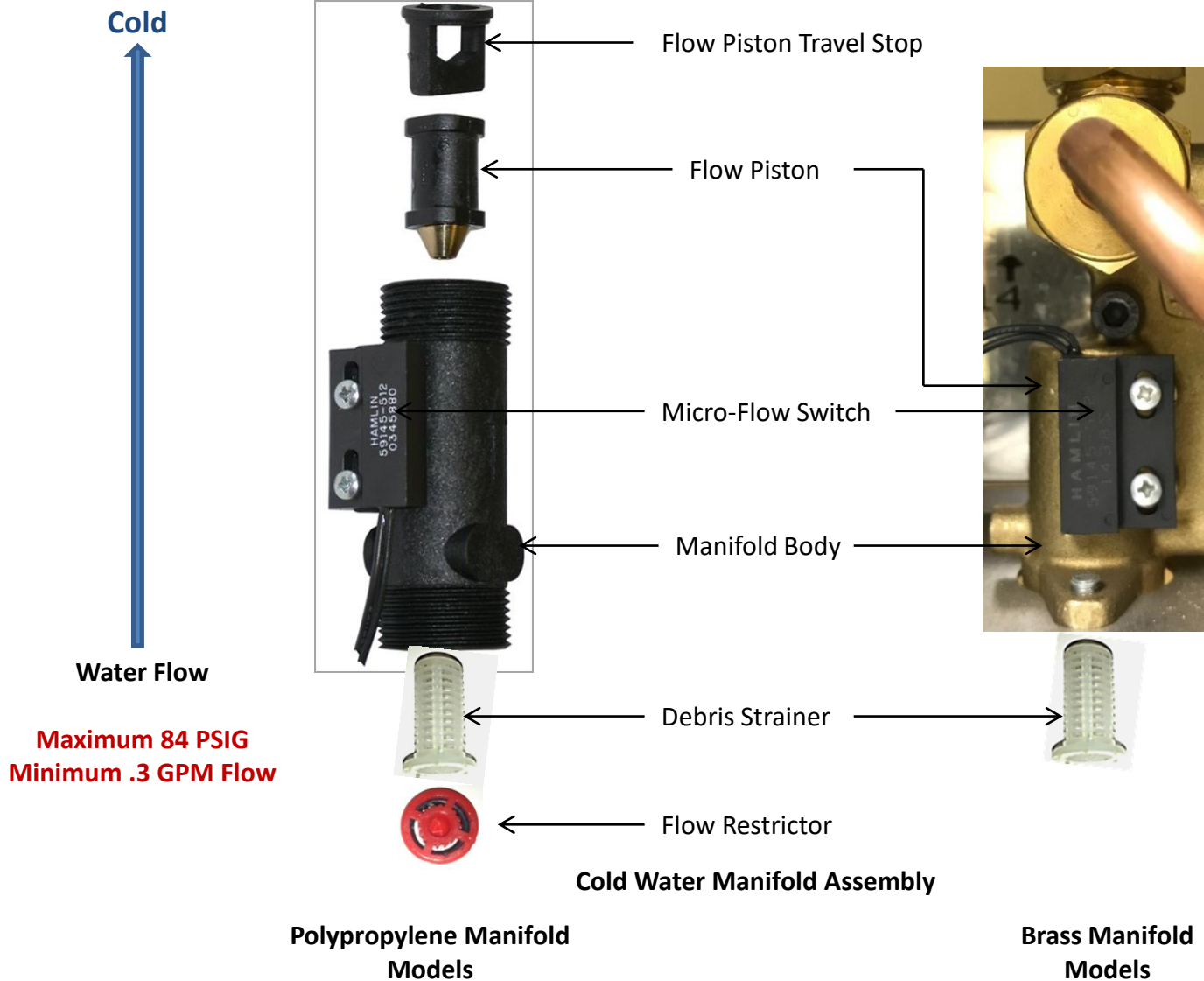

No Hot Water - Domestic Hot Water Flow Switch Operation

PCC and PCI Models

Hot



Water Flow

Maximum 84 PSIG
Minimum .3 GPM Flow



Polypropylene Manifold Models

D.H.W Temperature Sensor

Manifold Body

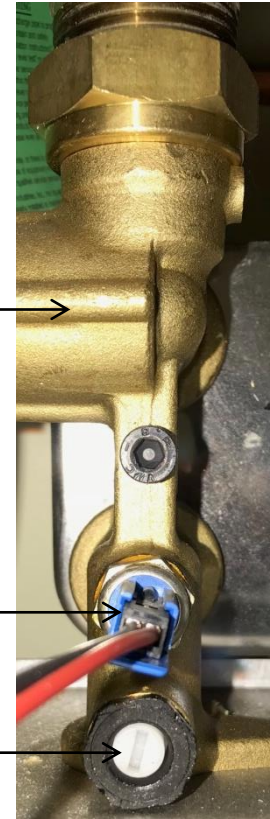

Adjustable Flow Restrictor

Hot Water Manifold Assembly

Brass Manifold Models

No Hot Water - Domestic Hot Water Flow Switch Operation

PCC and PCI Models

- Flow piston is magnetized
- Sealed Micro-flow switch closes by magnetic force when the flow piston is moved adjacent to the switch



Sequence of Operation (PCC and PCI Models – PCH Models Do Not Incorporate a D.H.W. Flow Switch)

1. Boiler is energized
 2. Domestic hot water is enabled on the control
 3. Hot and cold water shut off valves are open
 4. Cold water debris strainer is clean
 5. A hot water faucet is opened
 6. Cold water enters the manifold and lifts the Flow Piston
 7. Piston positions itself adjacent to the sealed Micro-flow switch
 8. Magnetic force closes the micro-switch and enables D.H.W. within the MPCB
 9. Circulator is enabled, diverter valve moves to the D.H.W. position
 10. If the D.H.W. temperature set point is above the temperature of the potable water at the D.H.W. temperature sensor; burner fires and modulates as necessary. When the D.H.W. reaches or exceeds the temperature of the potable water set point; burner is disabled. Burner is enabled once again when temperature of the potable water at the D.H.W. sensor drops below set point.
 11. Hot water faucet is closed
 12. Flow piston drops, magnetic force is removed and the micro-switch opens. D.H.W. is disabled within the MPCB
 13. Circulator continues to operate for 1 ½ minutes to purge heat from the primary heat exchanger.
 14. If 'Domestic Hot Water Priority' parameter is enabled, heat will be held off for 90 seconds after a D.H.W. call ends.
- If, during a call for D.H.W., the water temperature in the primary heat exchanger reaches 180 degrees F (+-), the burner will shut off on limit. Only to recycle once the temperature drops a few degrees at the heating sensor.

No Hot Water - Domestic Hot Water Flow Switch Operation

PCC and PCI Models

Sequence of Operation (PCI Models)

Please note:

PCI models incorporate an integral stainless steel indirect water heaters with temperature sensor. The sequence of operation is the same as previously described, with one exception:

The indirect water heaters in these models maintain water temperature based on the D.H.W. set point adjustment on the control panel. Accordingly, the temperature sensor can enable a D.H.W. call at the MPCB without a faucet being opened and the micro-switch closing.

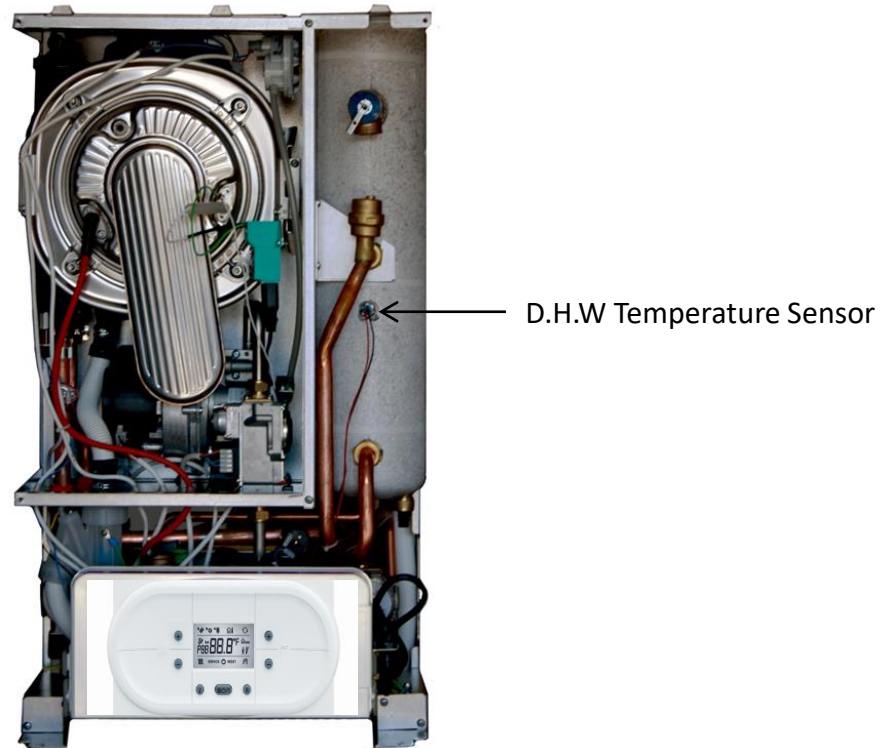

PCI 18/8 and PCI 34/20

No Hot Water - Domestic Hot Water Flow Switch Operation

PCC and PCI Models

Using a magnet to verify proper micro-flow switch operation:

- Disconnect power to the boiler
- Remove the two Philip head screws that secure the micro-flow switch to the manifold
- Carefully move the micro-flow switch to an accessible location
- Reconnect power to the boiler
- Place a magnet adjacent to the micro-flow switch, if D.H.W. is enabled (faucet flashes on the screen) the micro-flow switch and MPCB are in proper working order. If the burner will not fire and the D.H.W. set point is above the actual water temperature, verify the accuracy of the D.H.W. sensor (see page 65).



Defective Piston Travel Stop (Polypropylene Manifolds):

Rarely, under certain water quality conditions, the piston travel stop may become damaged and not stop the flow piston in the proper position. This defect will result in the following:

- When a hot water faucet is opened the D.H.W. circuit will be enabled for a second then disabled, remaining disabled as long as the faucet remains open. In this scenario, the flow piston is moving adjacent to and then past the micro-flow switch because of the defective piston travel stop. Remove, inspect, and replace the damaged piston travel stop and o-ring to remedy this problem.

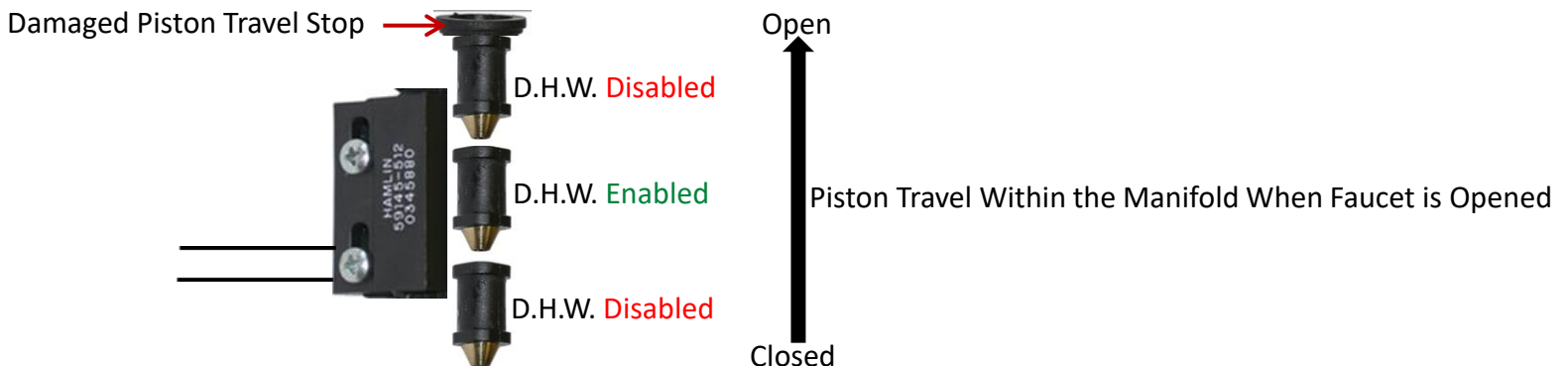

No Hot Water - Domestic Hot Water Sensors



PCC 34, PCI 18/8



PCH 18B, PCH 34B, PCH50B, PCI 34/20

Hot Water Sensors

1. PCC 34 and PCI 18/8: See illustration above. 10K, NTC sensor (thermistor). This model is screwed into a wet well and senses temperature by being immersed in the water. Replacement requires the domestic hot water circuit to be drained.
2. PCH 18B, PCH 34B and PCI 34/20: See illustration above. 10K, NTC sensor (thermistor). Sensor with wire cable. With the PCH 18B, PCH34B and PCH50B models, this sensor is inserted into the temperature well of an indirect water heater. On the PCI 34/20, the sensor is surface mounted on the integral 8 gallon indirect water heater.

NTC thermistors are resistors with a negative temperature coefficient, which means the resistance decreases with increasing temperature and vice-versa. 10K thermistors have 9,999 Ohms of resistance at 77 degrees F.

Temp	R	NTC	Temp	R	NTC	Temp	R	NTC	Temp	R	NTC	Temp	R	NTC
-20	105769		17.5	38780		55.5	15912		93	7196		131	3538	
-18	100544		19	37079		57	15289		95	6944		133	3428	
-16.6	95605		21	35463		59	14694		97	6702		134.5	3319	
-14.8	90934		23	33925		61	14126		98.5	6470		136.5	3216	
-13	86518		25	32461		62.5	13582		100	6247		138	3115	
-11	82339		27	31069		64.5	13062		102	6033		140	3021	
-9	78384		28.5	29743		66	12565		104	5828		142	2928	
-7.5	74641		30	28481		68	12090		106	5630		143.5	2839	
-6	71097		32	27279		70	11634		107.5	5440		145.5	2753	
-4	67739		34	26136		71.5	11199		108.5	5258		147	2669	
-2	64571		35.5	25044		73.5	10781		111	5082		149	2589	
0	61563		37	24004		75	10382		113	4933		151	2512	
1.5	58719		39	23014		77	9999		115	4751		152.5	2437	
3	56016		41	22069		79	9633		116.5	4590		154.5	2365	
5	53432		43	21168		80.5	9281		118.5	4444		156	2292	
7	51018		45	20309		82.5	8945		120	4300		158	2229	
9	48707		46.5	19489		84	8622		122	4161		160	2164	
10	46513		48	18708		86	8313		124	4026		162	2101	
12	44429		50	17959		88	8016		125.5	3897		163.5	2040	
14	42449		52	17245		89.5	7731		127.5	3773		165	1982	
16	40568		53.5	16563		91.5	7458		129	3653		167	1925	

No Hot Water - Domestic Hot Water Sensors

No Hot Water:

NTC sensors may, over time, become inaccurate. They are also susceptible to water damage at their wire terminal connections.

As such, an inaccurate sensor may adversely affect boiler operation. **Only a D.H.W. sensor with either an open or shorted circuit will enable the error code - E06**

- **PCH Models:** If a defective domestic hot water sensor is sending a false high temperature reading to the MPCB, higher than the hot water set point adjustment, the MPCB will not enable the domestic hot water circuit. Faucet will not flash, circulator and burner will not operate.
- **PCC and PCI Models:** If a defective domestic hot water sensor is sending a false high temperature reading to the MPCB, high than the hot water set point adjustment, the MPCB will be enabled by the domestic hot water flow micro-switch. Circulator will operate, diverter valve will rotate if necessary, but the burner will not fire.

Verify NTC Accuracy:

- **Inaccurate D.H.W. sensors can also result in lower than desired water temperature**
- Disconnect power to the boiler
- Disconnect the cable at D.H.W. sensor, figure 1, or at the MPCB for sensor in figure 2
- Measure the temperature at the sensor using an accurate electronic thermometer and record. If an electronic thermometer is not available, remove the sensor and place it in the air for several minutes to allow it acclimate to the temperature. Determine the room temperature in the vicinity of the sensor and record.
- Connect an ohms meter across the two wire terminals on the sensor in figure 1 or across the two wire leads to the sensor in figure 2. Record the ohms resistance.
- Using the resistance/temperature table on page 65, determine the accuracy of the sensor. If the recorded values do not match those in the table, replace the D.H.W. Sensor.
- If the values match and the micro-flow switch operates properly, replace and program the MPCB.



Fig 1



Fig 2

Domestic Hot Water Production

PCC and PCI models, combination heat and D.H.W. boilers, have limited hot water production based on the Btu output of the boiler. The amount of hot water available from these units can be calculated using the following formula:

$$\text{Btu Output of the Boiler} / \text{Temperature Rise of the Water} / 500 = \text{GPM}$$

Example:

- PCC34 Boiler Btu Output = 102,000 @ 88% Efficient
- Temperature Rise Desired = 70 Degrees F (50 Degree cold to 120 Degree hot)

$$102,000 / 70 / 500 = 2.91 \text{ GPM Maximum Available}$$

Not Enough Hot Water or Water is Not Hot Enough:

Before deciding that a boiler is operating incorrectly, verify that the D.H.W. demand is not greater than the boilers capacity.

1. Determine the flow rate of the faucet in question by determining how long it takes to fill a one gallon container.
2. Measure the cold waters' temperature entering the domestic water circuit of the boiler
3. Use the following formula to determine the maximum D.H.W. temperature the boiler is capable of delivering

Examples:

- PCC 34 Boiler – Btu Output = 102,000
- Measured hot water flow from kitchen faucet = 2.25 GPM
- Incoming cold water temperature = 45 Degrees F

$$102,000 / 2.25 \text{ GPM} / 500 = 91 \text{ Degree F Temperature Rise}$$

45 Degree Cold Water + 91 Degree Rise = 136 Degree F. Maximum Water Temperature Available at the Faucet

- PCC 34 Boiler – Btu Output = 102,000
- Measured hot water flow from tub fill = 5 GPM
- Incoming cold water temperature = 45 Degrees F

$$102,000 / 5 \text{ GPM} / 500 = 41 \text{ Degree F Temperature Rise}$$

45 Degree Cold Water + 41 Degree Rise = 86 Degree F. Maximum Water Temperature Available at the Tub Fill

Domestic Hot Water Production

As seen from the examples; the greater the GPM flowrate the lower the delivered hot water temperature, the lower the GPM flowrate the higher the delivered hot water temperature. Through use of the preceding formulas, one can determine if a hot water problem is the result of 'over-drawing' the boilers D.H.W. capability or a component problem.

Reference GPM Tables:

PCI 18/8					
Combustion Efficiency					
	93%	92%	91%	90%	89%
Temp Rise	GPM DHW				
60	2.66	2.64	2.61	2.59	2.56
61	2.62	2.6	2.57	2.54	2.52
62	2.58	2.55	2.53	2.5	2.48
63	2.54	2.51	2.49	2.46	2.44
64	2.5	2.48	2.46	2.42	2.4
65	2.46	2.44	2.41	2.39	2.36
66	2.42	2.4	2.38	2.35	2.33
67	2.39	2.36	2.34	2.32	2.29
68	2.35	2.33	2.31	2.28	2.26
69	2.32	2.3	2.27	2.25	2.23
70	2.29	2.26	2.24	2.22	2.19
71	2.26	2.23	2.21	2.19	2.16
72	2.22	2.2	2.18	2.16	2.13
73	2.19	2.17	2.15	2.13	2.1
74	2.16	2.14	2.12	2.1	2.08
75	2.13	2.11	2.09	2.07	2.05
76	2.11	2.08	2.06	2.04	2.02
77	2.08	2.06	2.04	2.02	1.99
78	2.05	2.03	2.01	1.99	1.97
79	2.03	2.01	1.98	1.96	1.94
80	2	1.98	1.96	1.94	1.92
81	1.98	1.96	1.94	1.92	1.9
82	1.95	1.93	1.91	1.89	1.87
83	1.93	1.91	1.89	1.87	1.85
84	1.91	1.89	1.87	1.85	1.83
85	1.88	1.86	1.84	1.83	1.81
86	1.86	1.84	1.82	1.8	1.79
87	1.84	1.82	1.8	1.78	1.77
88	1.82	1.8	1.78	1.76	1.75
89	1.8	1.78	1.76	1.74	1.73
90	1.78	1.76	1.74	1.72	1.71

PCC34					
Combustion Efficiency					
	93%	92%	91%	90%	89%
Temp Rise	GPM DHW				
60	3.59	3.55	3.52	3.48	3.44
61	3.53	3.5	3.46	3.42	3.38
62	3.48	3.44	3.4	3.36	3.33
63	3.42	3.38	3.35	3.31	3.27
64	3.37	3.33	3.3	3.26	3.22
65	3.32	3.28	3.25	3.21	3.17
66	3.27	3.23	3.2	3.16	3.12
67	3.22	3.18	3.15	3.11	3.08
68	3.17	3.13	3.1	3.07	3.03
69	3.12	3.09	3.06	3.02	2.99
70	3.08	3.04	3.01	2.98	2.95
71	3.04	3	2.97	2.94	2.9
72	2.99	2.96	2.93	2.9	2.86
73	2.95	2.92	2.89	2.86	2.82
74	2.91	2.88	2.85	2.82	2.79
75	2.87	2.84	2.81	2.78	2.75
76	2.84	2.8	2.77	2.75	2.71
77	2.8	2.77	2.74	2.71	2.64
78	2.76	2.73	2.7	2.67	2.61
79	2.73	2.7	2.67	2.64	2.58
80	2.69	2.66	2.64	2.61	2.54
81	2.66	2.63	2.6	2.57	2.51
82	2.63	2.6	2.57	2.54	2.48
83	2.6	2.57	2.54	2.51	2.45
84	2.56	2.54	2.51	2.48	2.42
85	2.53	2.51	2.48	2.45	2.39
86	2.51	2.48	2.45	2.42	2.37
87	2.48	2.45	2.42	2.4	2.34
88	2.45	2.42	2.4	2.37	2.31
89	2.42	2.39	2.37	2.34	2.29
90	2.39	2.37	2.34	2.32	2.26

Low Fire Rumble or Whistle

Rumbling or Whistling Noise is Heard From the Burner At Low Fire Only

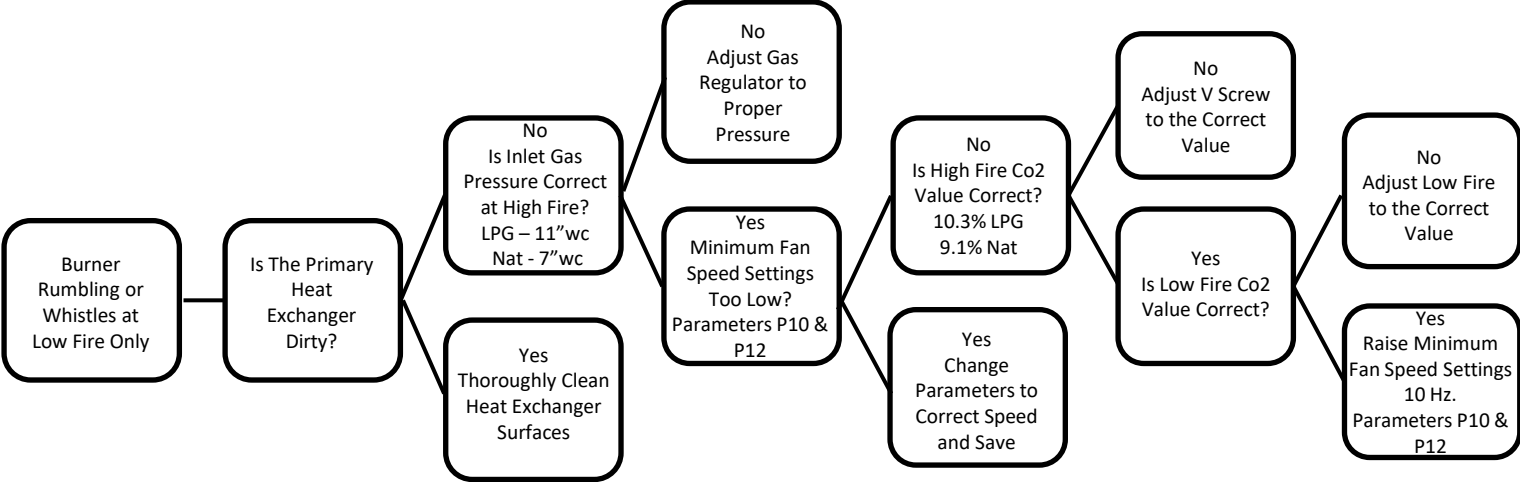

Low Fire Rumble or Whistle

1. Dirty or Plugged Primary Heat Exchanger:

If the boiler's flue gas temperature is above 172 degrees F., the primary heat exchanger must be cleaned. **Disconnect power to the boiler and shut the gas cock before cleaning. Electrical components must be protected. Protect the refractory within the heat exchanger. Wear proper personnel protective equipment.** Using a nylon brush and vacuum, clean the surface and between the sections of the heat exchanger. The majority of the heat exchanger's surface area lies between the sections. As such, it is imperative that this area be cleaned thoroughly and any restrictive deposits removed. Use a credit card thick plastic object to verify the flue gas passageways between the sections are clear. If the brush and vacuum does not clean the heat exchanger thoroughly, a light water spray can be used along with the nylon brush to loosen deposits. The water should pass between the sections, unrestricted, upon completion. If hard deposits still remain on or between the sections, CLR Cleaner in a spray bottle can be used to assist in their removal. Spray the CLR on the heat exchanger surface and allow it to penetrate the deposits. Do not allow the surface to dry. Brush the area and then flush the heat exchanger and condensate system thoroughly with clean water.

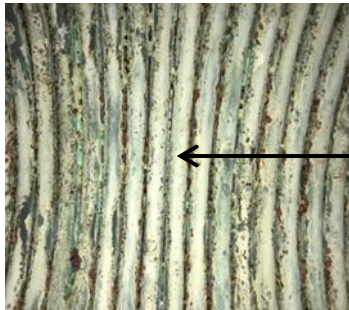

Dirty and Plugged H.E.

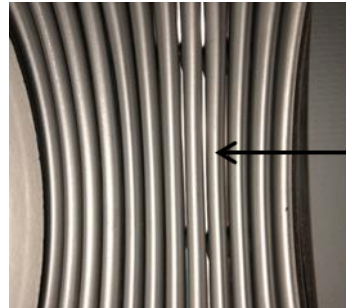

Open Flue Gas Passageways in H.E.



2. Gas Inlet Pressure

Disconnect power to the boiler. Shut off the gas cock. Open, then install a manometer on the inlet side test port (bottom) of the gas valve (refer to picture on page 71). Open gas cock and verify there is enough gas pressure displayed on the manometer. Natural gas 5-8" wc, LPG 10-14" wc. Turn up the heating thermostats, reconnect power to the boiler. After the burner fires, force it into high fire mode by pressing the 'R' button for several seconds. F07 will appear on the screen. Press the '+' heat temperature button for a second then release. Verify the burner is operating at high fire. Check the pressure on the manometer. If necessary, adjust the gas supply regulator to realize 11" wc for LPG or 7" wc for Natural gas. Turn the boiler off and verify the static pressure does not exceed 14" wc. **Gas inlet pressure in excess of 14" wc will damage the gas valve and necessitate its replacement.** Shut the gas cock and remove the manometer from the gas valve. Close the test port screw. Reopen the gas cock and turn the boiler on. Verify proper mode selection and boiler operation. Return the thermostats to their original settings.

Low Fire Rumble or Whistle

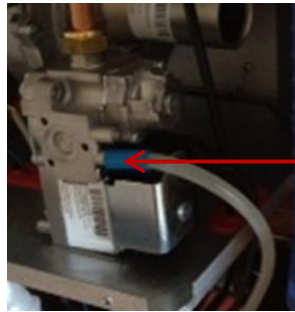

Loosen Screw, Do Not Remove, Connect Hose

3. Minimum Fan Speeds Too Low:

Refer to the Instruction Manual Section 5, Regulating the Appliance and Parameters Settings.

Access the parameter menu:

- Turn the boiler to the off position using the mode selection button
- Simultaneously press and hold both the 'I' and 'R' until the screen changes to the parameter menu (P00 and a value will illuminate)
- Using the Heat Temperature '+' and '-' buttons, advance or retard to Parameter P10 and verify the value shown on the screen matches the value in the instruction manual.
- If the values differ, the parameter value can be changed using the D.H.W. temperature '+' and '-' buttons
- Once the proper value is selected, it can be saved by pressing then releasing the mode selection button. The value will flash for a few seconds then stop, saving the changes
- Repeat the same for parameter P12
- To exit the parameter menu, simultaneously press and hold the 'I' and 'R' buttons until the screen returns to the 'Home' position
- Using the mode selection button, turn the boiler on and enable the proper function(s)
- Verify proper operation

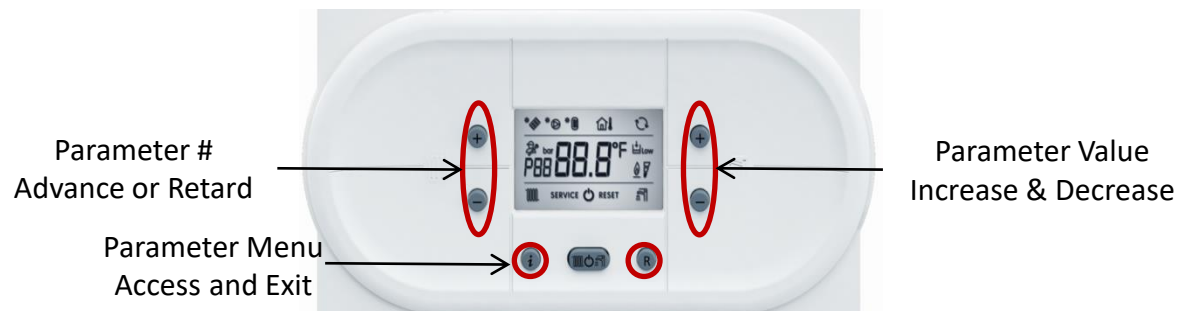

Low Fire Rumble or Whistle

4. Check High Fire CO₂

- Turn boiler off
- Turn up all heating thermostats
- Turn on electronic combustion analyzer and select proper fuel
- Turn boiler on, heat will be enabled (radiator icon will be flashing)
- Burner will fire
- Remove flue gas sampling port plug from the boilers flue adapter
- Insert combustion analyzers test probe into sampling port and secure
- Force the boiler into high fire by pressing the 'R' button until F07 appears on the screen
- Press the '+' Heat temperature button and verify the boiler is operating in high fire
- Observe the CO₂ value on the analyzer and wait for it to stabilize
- Compare the test value to the values in the table below
- If different, adjust the V-Screw using a 4mm Allen wrench until the proper value is obtained (counter-clockwise to increase CO₂, clockwise to reduce)
- Disable the high fire mode by turning the boiler off with the mode selection button
- Remove the combustion analyzer and reinsert the plug
- Turn the boiler on and enable the proper modes
- Verify proper boiler operation
- Return heating thermostats to their original settings

Boiler Model	Gas Type	CO ₂ %
PCH 34B H	Nat	9.1
	LPG	10.3
PCH 50B H	Nat	9.4
	LPG	10.3
PCC 34 H	Nat	9.1
	LPG	10.3
PCI 18/8 H	Nat	9.3
	LPG	10.1
PCI 34/20 H	Nat	9.1
	LPG	10.3

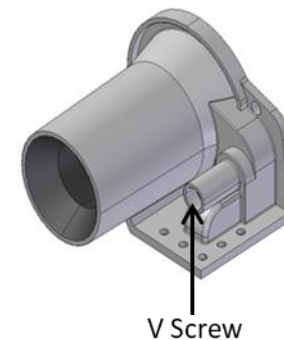

Low Fire Rumble or Whistle

5. Check Low Fire CO2

- Turn boiler off
- Turn all heating thermostats several degrees above room temperature
- Turn on the electronic combustion analyzer and set to the proper gas
- Turn boiler on and 'Heat' will be enabled (radiator flashing)
- Burner will fire
- Press and hold the reset button (R) until F07 appears on the screen
- Burner will modulate to low fire and remain there for 15 minutes*
- Remove flue gas sampling port plug from the vent adapter
- Insert analyzers' sampling probe into the test port and secure
- Wait for CO2 reading to stabilize on the analyzer and then compare it to the values in the table below:

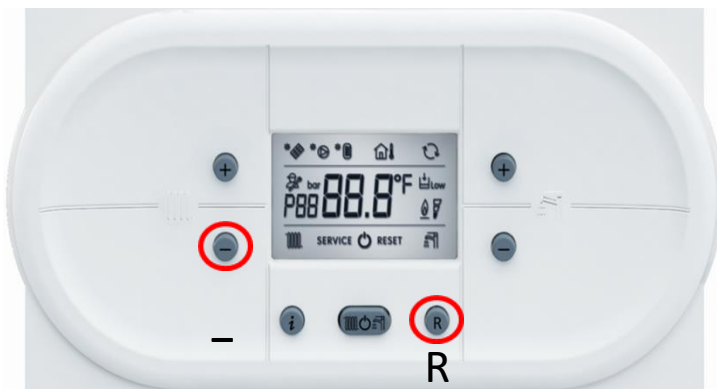

Boiler Model	Gas Type	CO ₂ %
PCH 34B	Nat	9.0
	LPG	10.1
PCH 50B	Nat	9.2
	LPG	10.1
PCC 34	Nat	9.0
	LPG	10.1
PCI 18/8	Nat	9.1
	LPG	9.8
PCI 34/20	Nat	9.0
	LPG	10.1

- If the values differ, the low fire CO2 will need to be adjusted

*If the boiler does not modulate to low fire upon pressing the 'R' button, press and release the heat temperature '-' button. If it still doesn't modulate to low fire you have an older version of the MPCB. This will require you to access parameter P12 'Minimum Fan Speed – Heating' to enable low fire operation. Once the parameter is accessed, the burner will fire and immediately go to low fire, staying there for 15 minutes before automatically disabling itself. See instruction manual 'Accessing the Parameters Menu' section for additional information.

Low Fire Rumble or Whistle

- Locate Low Fire adjustment screw cover on the gas valve and remove it with a T40 Torx bit. The adjustment screw is beneath.

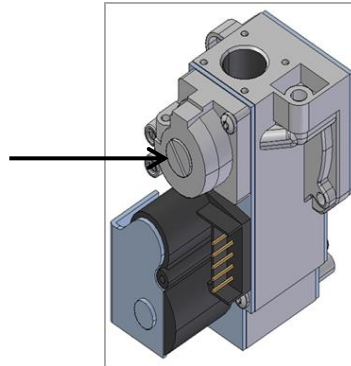

- Using the same T40 bit inserted into the adjustment screw, the Low Fire CO2 value can be adjusted. **This screw is extremely sensitive, make small incremental adjustments.** Turn the adjustment screw clockwise to increase the CO2 value, counter-clockwise to reduce. Adjust to match the value in the table on page 73.
- When finished, replace the adjustment screw cover
- Press the controls mode selection button to the off position to disable low fire. *
- Remove combustion analyzer probe from the test port and reinstall the test plug
- Turn the boiler on using the mode selection button
- Verify proper mode selection and boiler operation
- Return heating thermostats to their original settings

*Older versions of the control will require you to exit parameter P12 'Minimum Fan Speed – Heat' to disable low fire. Simultaneously press and hold both the 'i' and 'R' buttons until the control reverts back to the standard screen. See instruction manual for additional information.

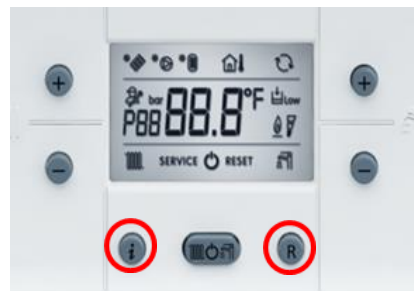

Low Fire Rumble or Whistle

6. Minimum Fan Speeds Too Low:

Refer to the Instruction Manual Section 5, Regulating the Appliance and Parameters Settings for additional information

Access the parameter menu:

- Turn the boiler to the off position using the mode selection button
- Simultaneously press and hold both the 'I' and 'R' buttons until the screen changes to the parameter menu (P00 and a value will illuminate)
- Using the Heat Temperature '+' and '-' buttons, advance or retard to Parameter P10 and record the value.
- Using the D.H.W. temperature '+' button increase the value 10 points
- Save the new value by pressing then releasing the mode selection button. The value will flash for a few seconds then stop, saving the change
- Repeat the same for parameter P12
- To exit the parameter menu, simultaneously press and hold the 'I' and 'R' buttons until the screen returns to the 'Home' position
- Using the mode selection button, turn the boiler on and enable the proper function(s)
- Verify proper boiler operation

